



WF610BL

Freestanding

Dishwasher

Installation, Use and Maintenance

Important

The CDA Group Ltd cannot be held responsible for injuries or losses caused by incorrect use or installation of this product. Please note that CDA reserve the right to invalidate the guarantee supplied with this product following incorrect installation or misuse of the appliance.

This appliance is not designed to be used by people (including children) with reduced physical, sensorial or mental capacity, or who lack experience or knowledge about it, unless they have had supervision or instructions on how to use the appliance by someone who is responsible for their safety.

Under no circumstances should any external covers be removed for servicing or maintenance except by suitably qualified personnel.

Appliance information:

Please enter the details on the appliance rating plate below for reference, to assist CDA Customer Care in the event of a fault with your appliance and to register your appliance for guarantee purposes.

Appliance Model	
-----------------	--

Serial Number	
---------------	--

This appliance has been designed for domestic use only. Commercial use will invalidate the guarantee.

CE Declarations of Conformity:

This appliance has been designed, constructed and marketed in compliance with safety requirements of EEC Directives 2004/108/EC, 2006/95/EC, IEC436/DIN44990 & EN 50242.

IMPORTANT INFORMATION FOR CORRECT DISPOSAL OF THE PRODUCT IN ACCORDANCE WITH EC DIRECTIVE 2002/96/EC.

At the end of its working life, the product must be taken to a special local authority waste collection centre or to a dealer providing appliance recycling services.

Disposing of a household appliance separately avoids possible negative consequences for the environment and health. It also enables the constituent materials to be recovered, saving both energy and resources. As a reminder of the need to dispose of household appliances separately, the product is marked with a crossed-out wheeled dustbin.



Important

- Read the instructions prior to installation and use of the appliance.
- Do not lean or climb on the open dishwasher door to prevent damage.
- Close the dishwasher door after use to prevent accidents.
- Use only detergents, salt and rinse aid specifically designed for dishwashers.
- Do not put solvents in the dishwasher detergent compartment to prevent risk of explosion.

-
- Only put dishwasher safe items into the dishwasher. If in doubt, check with the manufacturer of the items.
 - Take care when loading the dishwasher to observe the recommendations for best loading practice, and also to ensure that sharp objects such as knives are placed blade down to prevent accidents.
 - Do not open the dishwasher door when a programme is running. If it is necessary to do so, then open it only slightly to allow the dishwasher to pause the programme and prevent any water spilling out. Remember that the water in the dishwasher can be very hot when the programme is running.
 - When the dishwasher is not in use, we recommend that you turn off the water supply at the supply tap and disconnect the main supply.
 - If you are leaving the dishwasher for an extended period you should leave the door slightly open to prevent the formation of unpleasant smells.
 - The plastic housing on the water inlet pipe contains an electrically operated valve. The wires that connect to this valve are inside the inlet hose. Do not cut through the inlet hose, and do not put the plastic housing in water.
 - Children could get locked inside the appliance. Therefore when disposing of an old appliance, cut off the plug and set aside, and damage the door lock so that the door can no longer be closed.
 - When correctly installed, your product meets all safety requirements laid down for this type of product. However, special care should be taken around the rear or the underneath of the appliance as these areas are not designed or intended to be touched and may contain sharp or rough edges that could cause injury.

Recommendations

- To reduce energy and water consumption, remove all dirt residues from the dishes prior to loading the dishwasher.
- Only run the dishwasher when fully loaded.
- Place hollow items (bowls, glasses and pans) face down in the basket.
- Do not put dishes or cutlery with tobacco ash, wax, lubricating grease or paint residues in the dishwasher.

Before First Use

- Set the water softener level as required by the water hardness in the area.
- Add 2kg of salt into the salt compartment and then fill with water to the top of the salt compartment.
- Remove all the packaging materials from the interior of the dishwasher.
- Fill the rinse aid compartment.
- Run a hot programme without any dishes in the dishwasher.

Control Panel

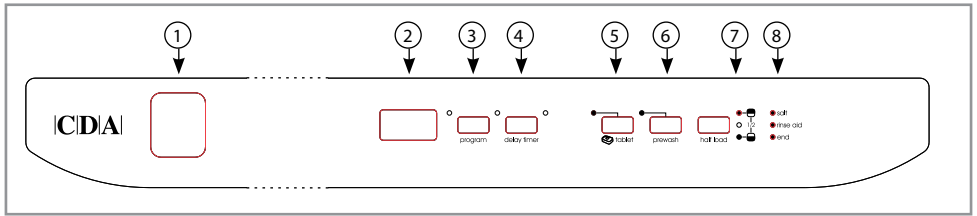

Power button (1)

- To switch the dishwasher on or off, press the power button (1). When you switch on the dishwasher, the end of programme light will illuminate, and two dashes will appear on the display.

Programme display (2)

The programme display shows the selected programme and the remaining time to run. If there is a fault on the dishwasher, the fault code will show on the display.

Programme selection button (3)

- To select a programme, press the programme selection button (3). The dishwasher will store in its memory the last programme used.

Delay timer button (4)

The dishwasher is equipped with a variable timer of up to 19 hours duration, at hourly intervals.

- To set the delay timer, press the delay timer button (4). This will switch the timer on for one hour.
- To change the delay duration, press the delay timer button again until the required delay duration is shown on the display, alternating with the selected programme and the programme duration.

- To cancel the delay timer, press the delay timer button again until “0h” shows on the display.

3 in 1 function button (5)

The dishwasher is equipped with a tablet function that automatically adjusts the amount of rinse aid and dishwasher salt used during a programme.

- To use this function, press the button after selecting the programme, before you close the door.

Prewash button (6)

The dishwasher is equipped with a prewash function that automatically adds a prewash to the selected programme. The prewash function improves the wash performance of the programme, but also can change the temperature and duration of the programme.

- To use this function, press the button after selecting the programme, before you close the door.

The prewash is also an independent programme (8) which can be used to rinse the contents of the dishwasher, for example if the dishwasher is not yet full and a complete programme is not yet required.

- To do so, select the programme as described below.

Half-load button (7) and indicator lights

The dishwasher is equipped with a half-load function that allows for either the upper or lower basket to be washed independently, or for both baskets to be washed if they contain only a small number of dishes.

- To use this function, press the half-load button (7) until the indicator light shows next to the required section of the dishwasher, either upper, lower or both lights (if both baskets are to be washed together).

Salt and rinse aid warning lights (8)

When the dishwasher salt or rinse aid begins to run out, the warning light will illuminate to advise that it needs refilling.

End of programme light (8)

When the programme is complete, the dishwasher will emit five beeps and the end of programme indicator light will illuminate.

Please note: You should ensure that there are no dishes in the upper basket when running a lower basket half-load programme, and none in the lower basket when running an upper basket half-load programme.

If you have selected any extra function (3 in 1, prewash or half-load) for a programme, this function will automatically be selected the next time the dishwasher is used. To cancel the selection of any extra function, press the specific extra function button (5, 6 or 7) until the indicator light for that function goes out.

Starting a programme

- Press the Power button (the end of programme light will be switched on).
- Press the Programme Selection button until the required programme is shown on the display.

- If required, set the delay timer by pressing the Delay Timer button
- Once a programme is selected, the end of programme light will switch off.
- When you close the dishwasher door, the programme will start automatically.

Please note: The dishwasher stores the most recently used programme in its memory. To change the programme, simply press the Programme Selection button.

At the end of a programme

If possible, do not open the dishwasher door once the programme has started.

At the end of a programme, the dishwasher will beep five times, and the end of Programme Indicator light will switch on.

Changing a programme

It is possible to change the programme if necessary once the programme has started.

- First open the door slightly to reduce the risk of water spillage.
- Press the programme selection button until the required programme is shown on the display.
- Then close the door. The dishwasher will begin the new programme from the point at which the old programme stopped.

Cancelling a programme

It is possible to cancel the programme once it has started.

- First open the door slightly to reduce the risk of water spillage.

- Press and hold in the Programme Selection button for three seconds until the end of programme indicator flashes and a “1” shows on the display.
- Then close the door.

The dishwasher will run a drain cycle which will take approximately 30 seconds. Once this is complete, the dishwasher will beep five times and the end of programme light will switch on.

Switching the dishwasher off

- Once the dishwasher beeps five times and the end of programme light switches on, the dishwasher can be switched off by pressing the Power button.
- Then turn off the water tap and remove the plug from the power socket.

Please note: the dishwasher will automatically continue on the programme it has started after the door is opened and closed. or after the event of a power cut.



Interior lighting

The interior light in this appliance may be switched between two operating modes:-



- Economy mode - When the door is opened the light comes then automatically switches off after four minutes, or when the door is shut, whichever comes first.

- Normal mode - The interior light comes on when the door is opened and stays on until the door is shut again. This will stay on however long the door stays open, as long as the power supply is connected to the machine.

To change from economy mode to normal mode

- Open the dishwasher door and switch the main on/off switch to the “on” position (if not already switched on).
- Press the “3 in 1” button and the “Prewash” button   at the same time and hold down for three seconds, .
- The display will show “ILO” for 2 seconds to confirm the setting.

To change from normal mode to economy mode

- Open the dishwasher door and switch the main on/off switch to the “on” position (if not already switched on).
- Press the “3 in 1” button and the “Prewash” button   at the same time and hold down for three seconds.
- The display will show “IL1” for 2 seconds and the interior light flashes off and on to confirm the setting.

Note: The machine is set to the economy mode when it leaves the factory.

Detergent

To fill the detergent compartment

1. Push the latch to open the compartment.
2. Add the required amount of detergent. The main detergent compartment “b” (figure 1) has lines to allow for specific amounts of detergent. These are marked at either 15cm³ or 25cm³, to be used depending on how dirty the dishes are. If your dishes are in need of an intensive wash, then add 5cm³ of detergent into the prewash section of the compartment “a” (figure 1).
3. Then close the detergent compartment lid until the latch locks.

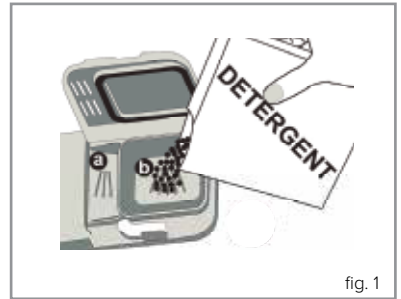

Please note: You should only use detergents designed specifically for use in dishwashers.

If using dishwasher tablets, always use the detergent compartment, do not put them in the main body of the dishwasher or in the cutlery basket. The solubility of dishwasher tablets can vary depending on the temperature and duration of the programme. As a result, it is recommended that powder detergents should be used in the shorter programmes to allow better performance.

CDA recommends the use of separate detergent, rinse aid and dishwasher salt rather than combination tablets as separates achieve better wash performance.

If you do use combination detergents, add salt and rinse aid to the dishwasher. Then adjust the water hardness setting and rinse aid setting to the minimum. When you then use separate detergents again, you should fill the salt and rinse aid compartments, adjust the water hardness setting to the maximum and run an empty wash, then adjust the water hardness setting and the rinse aid setting to the appropriate level.

Salt

To ensure the best efficiency, the dishwasher needs soft water. Hard water means that lime residues remain on the dishes and the interior of the dishwasher, affecting performance. The softener system is designed to remove the ions that make the water hard to provide the best quality wash performance. This is achieved by using dishwasher salt.

To add dishwasher salt, follow the steps below:

1. Remove the lower dishwasher basket and then unscrew the salt compartment cap, as shown in figure 2.
2. Fill the compartment with dishwasher salt (do not use table salt), carefully to prevent unnecessary spillage (figure 3). Before first use, you should fill the compartment with 2kg of dishwasher salt and then fill up the salt compartment with water (up to the brim of the compartment) as shown in figure 3.
3. Replace the cap and the lower basket.

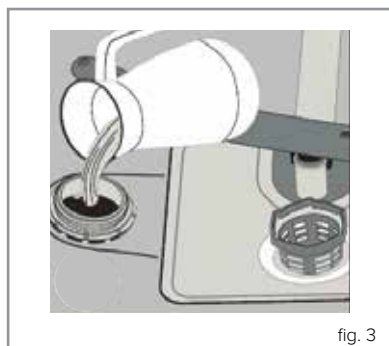
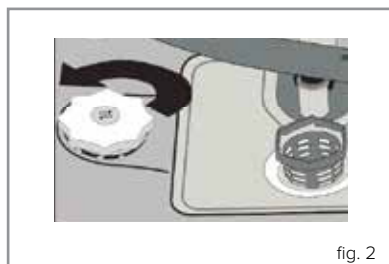

When the salt warning light on the control panel illuminates, you should refill the salt compartment with salt only – do not add water to the salt compartment after the first use.

Important:

You should run a prewash programme immediately after adding dishwasher salt, to prevent any damage to the dishwasher systems.

Softener Adjustment

The efficiency of your dishwasher depends on the softness of the tap water. To ensure best efficiency, the dishwasher is equipped with a system that reduces the hardness in the mains water supply. The efficiency will increase when the system is correctly set. To find out the water hardness level of your water supply you can use the test strip supplied or alternatively contact your local water board.

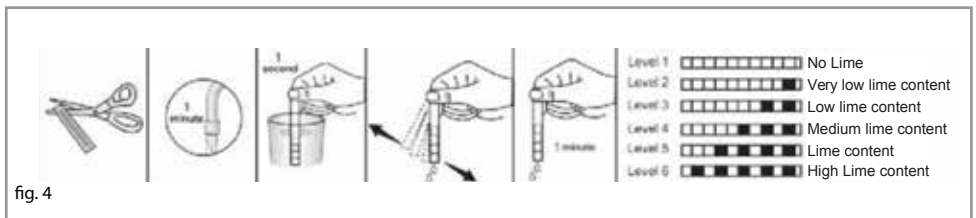

1. Open the testing strip (figure 4).
2. Run water through the tap for one minute.
3. Hold the testing strip in the water for one second.
4. Remove from the water and shake the test strip to remove excess water.
5. Wait for one minute.
6. Check the number of marks on the strip to see the level of water hardness.

If the hardness of the water you use is above 63dE, or if you are using well water, you are recommended to contact your local water board to confirm the water hardness level and to use filter and water refinement devices.

Please note: The level of water hardness is preset to level 3.

1. Press and hold down the programme selection button
2. Press the Power button to switch on the dishwasher
3. Keep the programme selection button pressed until “SL” shows on the display and then disappears
4. To adjust the level, press the programme selection button until the required level is shown on the display, as listed in the Table of Water Hardness below

Water hardness level	British hardness dE	Display shows
1	0-6	L1
2	7-14	L2
3	15-21	L3
4	22-28	L4
5	29-39	L5
6	40-63	L6

5. To store the selected water hardness level, press the power button.

Rinse Aid

To fill the rinse aid compartment

1. Open the rinse aid compartment by turning and removing the cap as shown in figure 5.
2. Fill the rinse aid compartment until the rinse aid indicator goes dark, as shown in figure 6 (where “a” indicates the compartment is empty, and “b” indicates the compartment is full).
3. Replace the cap, ensuring the markers on the cap line up with the compartment prior to screwing the cap back in place.

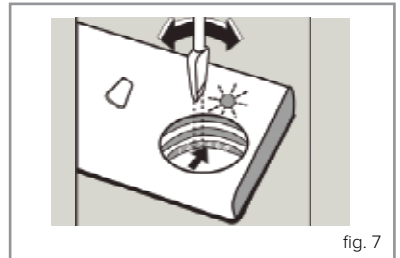
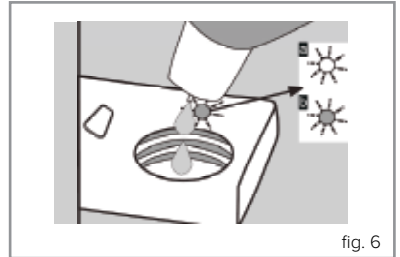
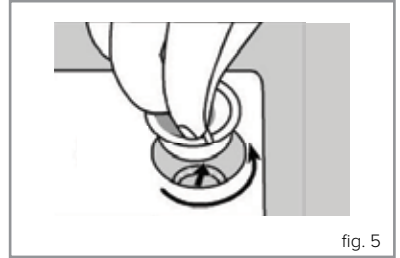

Rinse Aid Adjustment

The level of rinse aid use is preset to 3. You can adjust the level of rinse aid use by adjusting as shown in figure 7.

- If water stains form on the dishes after a wash, the level should be increased.
- If blue stains which can be wiped away are left on the dishes after a wash, the level should be decreased.

Please note: Rinse aid ensures better quality wash results and increased drying performance.

Always refill the rinse aid when the rinse aid indicator light on the control panel is illuminated.

Dishwasher Baskets

The middle basket has two different heights available, to allow for larger products in either the middle or lower basket. To raise or lower the middle basket:

1. Take hold of the basket handles, as shown in fig. 8.
2. Raise the basket up as high as possible, then lower it down until it stops.

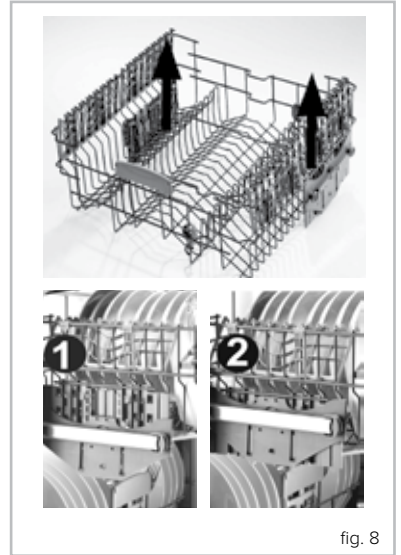

fig. 8

The images below are designed as guidance as to best practice for loading the dishwasher.

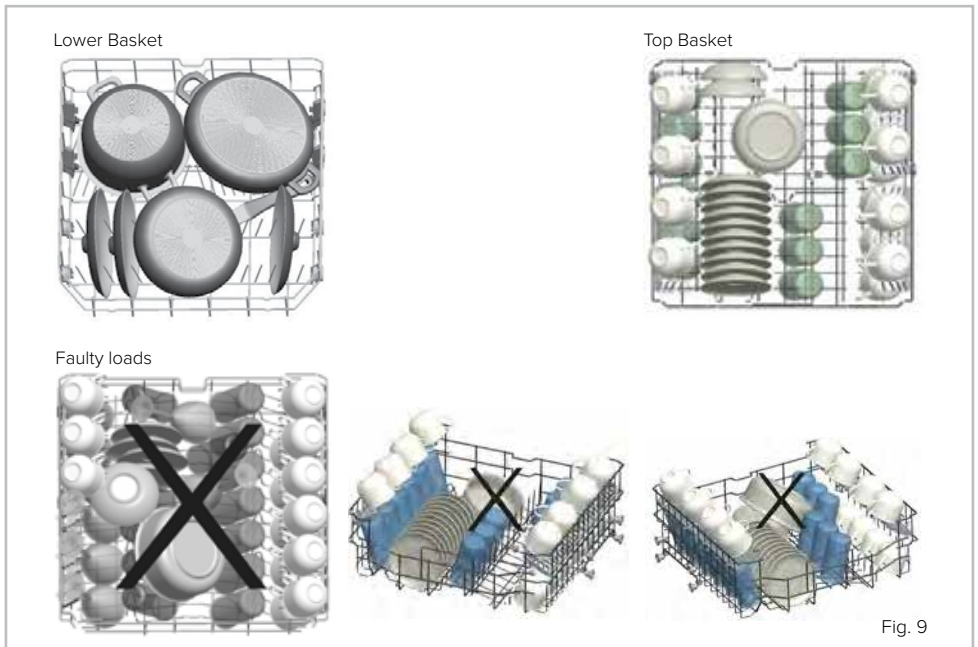

Fig. 9

Adjustable cup racks

The dishwasher is equipped with adjustable cup racks on the middle basket to allow long stemmed glasses to rest securely during washing, or stacking of smaller cups. The cup racks can also be folded up when not required to allow more space for larger items.

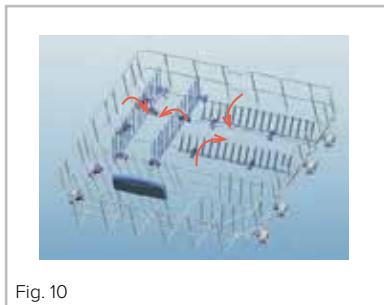

Fig. 10

Folding racks in middle and lower basket

The dishwasher is equipped with folding plate racks for the middle and lower baskets to offer the option of different uses of space as shown in fig. 10. To fold the rack down, push the rack downwards. To stand the rack upright, lift the rack up.



Fig. 11

Upper cutlery tray

The dishwasher is equipped with a two section cutlery tray as the upper basket. Each section of the cutlery basket is removable from the dishwasher for ease of loading and unloading and also to allow better loading of the middle basket to create more washing space, as shown in fig. 11.

Top basket height adjustable racks

The top basket is equipped with adjustable side racks as shown in fig. 12. After placing glasses in the upper basket these side racks can be placed at one of two heights to stand further items on: These may be used to hold longer knives/forks etc placed horizontally.

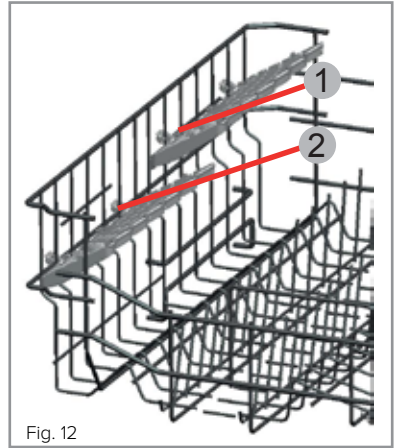

Top basket folding racks

The top basket is also equipped with folding racks as shown in fig. 13. These may be raised or lowered depending on whether they are needed to support crockery or if a clear space is required for holding larger pots.

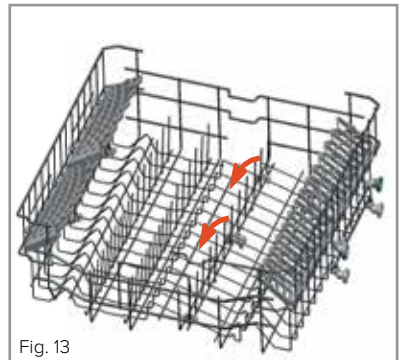

Standard Loading and Test Data

Capacity

- Middle and lower baskets: 15 place settings.
- The middle basket should be adjusted to the lowest position.

Detergent / Rinse aid

- 5 + 25 cm³, in accordance with EN50242-DIN 44990 IEC 436 (international norms) / Rinse aid dosage adjustment: 4.

Programme test

- Eco 50°C, in accordance with EN 50242 (international norms.).

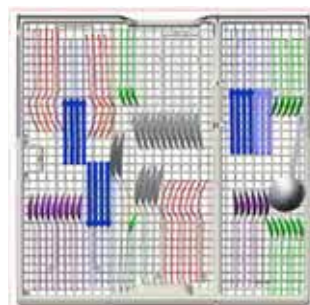
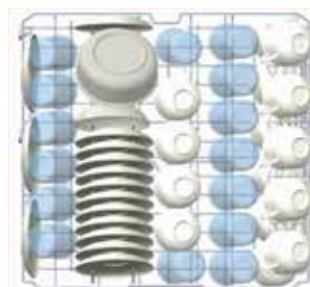
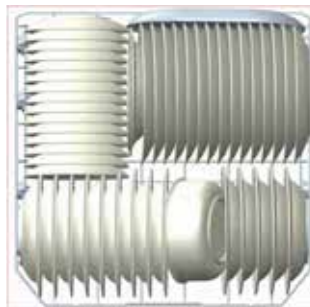
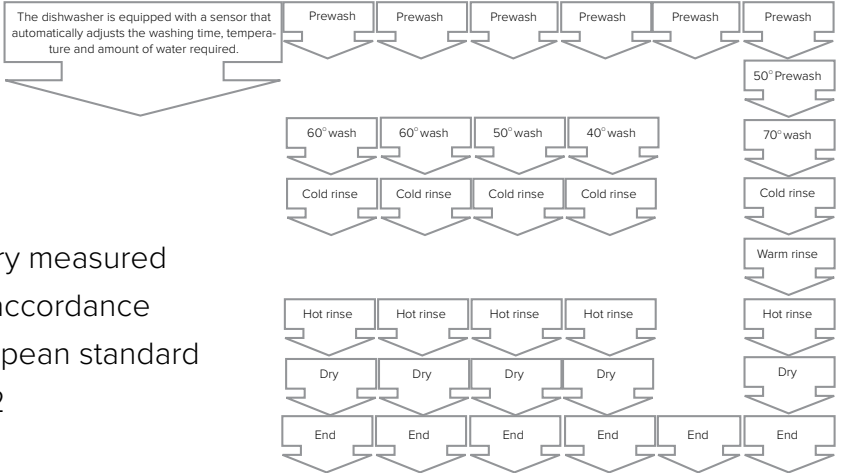

fig. 14

Programme Listing

Programme name and temperature	Auto Intensive 60-70°	Auto-normal 50-60°	Auto-delicate 30-50°	Intensive 60°	Express 60°	Eco 50°	Quick 40°	Prewash -	Intensive+ 70° (Intensive 60° and prewash function)
Level of soil	High	High	Low	High	Medium	Medium	Low	-	High
Detergent req'd A: 5cm ³ B: 25cm ³ / 15cm ³	A+B	A+B	B	A+B	A+B	A+B	B	-	A+B



Laboratory measured value in accordance with European standard EN50242

Programme duration (mins.)	111-183	100-127	64-92	123	55	162	30	15	161
Electricity consumption (kW hours)	1.22-1.8	1.12-1.3	0.81-0.96	1.55	1.07	0.94	0.88	0.02	1.75
Water consumption (liters)	13.3-24.6	10.9-18.5	10.6-17.7	15	11	9.0	11	4.2	22.7

The values and times provided above have been obtained under laboratory conditions according to relevant standards. Actual results obtained can vary depending on the conditions of the dishwasher's use and environment. (mains supply voltage, water pressure, water input temperature and environment temperature).

Care and Maintenance

Before beginning any care or maintenance, you should always disconnect the appliance from the electricity supply, and also turn off the water supply.

Door seals

Wipe the dishwasher door seals regularly with a damp cloth to remove any residues.

Filters

You should clean the filters at least once a month.

1. Remove the lower basket.
2. Turn the microfilter anti-clockwise and then lift it out as in figure 15.
3. Remove the coarse filter from the microfilter (figure 16).
4. Remove the base filter from the dishwasher compartment (figure 17).

You should clean and rinse the filters thoroughly before replacing all the sections in reverse order to that above. The microfilter should lock into place once it is secure as shown in figure 18.

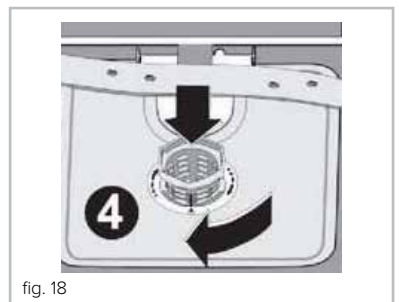
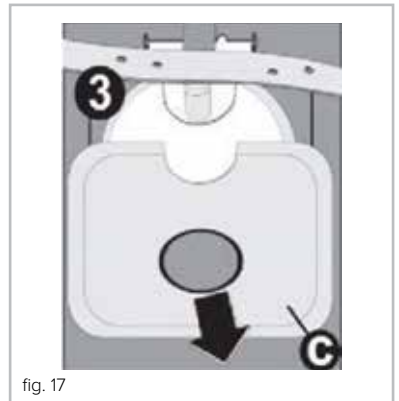
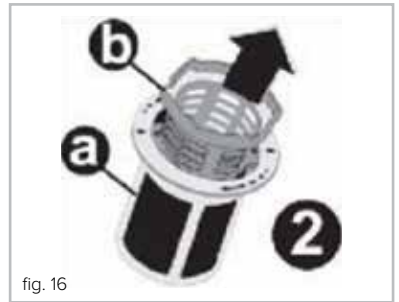
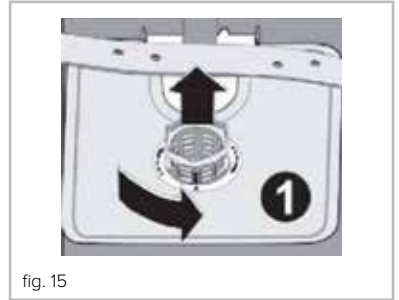

Please note: Never run a programme without the filters in place. Incorrect fitting of the filters may reduce wash performance and potentially damage your appliance.

Spray arms

You should clean the spray arms at least once a month.

1. Remove the lower basket
2. Pull the lower spray arm upwards to remove it.
3. To remove the upper spray arm, first remove the nut on the upper spray arm by turning it.

You should clean and rinse the spray arms thoroughly before replacing them. Ensure that the upper spray arm nut is securely tightened when refitting the upper spray arm.













Dishwasher interior

To deal with an accumulation of dirt, oil or limescale in the dishwasher, run an intensive programme with detergent when the dishwasher is empty.

Alternatively, there are specialist dishwasher cleaners available that can be used.

Failure Codes and Troubleshooting

The programme indicators also serve as a diagnostic display to help in the event of a problem with the appliance.

Error Code	Error description	Advice
	Water leakage has been detected	<ul style="list-style-type: none"> • Turn off the dishwasher and disconnect the water supply • Contact CDA Customer Care
	The waste water cannot be discharged	<ul style="list-style-type: none"> • Drain hose is blocked • The filters of your machine might be blocked • Restart the dishwasher and cancel the programme • If the error continues, contact CDA Customer Care
	Continual fill error	<ul style="list-style-type: none"> • Contact CDA Customer Care
	Faulty flow meter	<ul style="list-style-type: none"> • Contact CDA Customer Care
	Inadequate water supply	<ul style="list-style-type: none"> • Make sure the water tap is fully open • Close the water tap, separate the water inlet hose from the tap and clean the filter. • Restart the dishwasher. • If the error continues, contact CDA Customer Care
	Faulty NTC	<ul style="list-style-type: none"> • Contact CDA Customer Care
	Water temperature too high	<ul style="list-style-type: none"> • Contact CDA Customer Care
	Heater error: Inadequate heat	<ul style="list-style-type: none"> • Contact CDA Customer Care
	Diverter position problem	<ul style="list-style-type: none"> • Contact CDA Customer Care
	Alarm is active against water overflow	<ul style="list-style-type: none"> • Contact CDA Customer Care
	Electronic card parameter faulty	<ul style="list-style-type: none"> • Contact CDA Customer Care
	Electronic card water hardness faulty	<ul style="list-style-type: none"> • Check the water hardness is set for your water supply • If the error continues, contact CDA Customer Care
	Faulty turbidity sensor	<ul style="list-style-type: none"> • Contact CDA Customer Care

Failure Codes and Troubleshooting

Problem	Possible cause
The programme will not start	<p>Check the plug, fuse and circuit breakers of the mains supply.</p> <p>The water tap is turned off.</p> <p>The dishwasher door is not fully closed.</p> <p>The water inlet filter or the machine filters are blocked.</p>
Water remains inside the dishwasher at the end of a programme	<p>The water drain hose is blocked or kinked.</p> <p>The filters are blocked.</p>
The dishwasher stops in the middle of a programme	<p>Power failure.</p> <p>Water inlet failure.</p> <p>Programme is on standby.</p>
Wash performance is of a low standard	<p>Poor loading of dishes hinders wash performance.</p> <p>Insufficient detergent added.</p> <p>Inappropriate wash programme selected.</p> <p>Spray arm is blocked.</p> <p>Filters clogged or incorrectly fitted.</p> <p>Water drain pump is blocked.</p>
White stains on the dishes	<p>Insufficient detergent added.</p> <p>Rinse aid setting is too low.</p> <p>Insufficient dishwasher salt added.</p> <p>Water softener setting is too low.</p> <p>Salt compartment cap may not be completely closed.</p>
The dishes are not completely dry at the end of a programme	<p>A programme without a drying stage was selected.</p> <p>Rinse aid setting is too low.</p> <p>Dishes unloaded too soon (allow time for drying).</p>
There are rust stains on the dishes	<p>Different sets of cutlery should be kept separate.</p> <p>Too much salt (water softener setting is too high).</p> <p>Salt compartment cap not completely closed.</p> <p>Poor appliance earth (check mains electrical supply).</p>
The door is not opening or closing properly	<p>Door tension not correctly adjusted for the decor door.</p>

Electrical information

Warning! This appliance must be earthed.

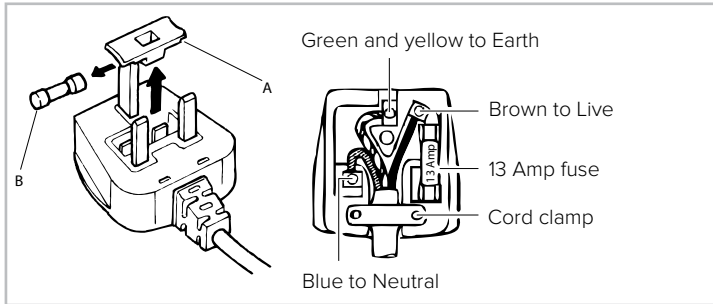

The mains lead of this appliance has been fitted with a BS1363A 13Amp fused plug. To change a fuse in this type of plug, follow the steps below:

1. Remove the fuse cover and fuse.
2. Fit replacement 13A fuse, ASTA approved to BS1362 type, into the fuse cover.
3. Replace fuse cover.

Important: Do not use the appliance without the fuse cover in position.

How to connect an alternative plug

If the fitted plug is not suitable for your socket outlet, then it should be cut off and disposed of safely to avoid the risk of electric shock. A suitable alternative plug of at least 13 Amp rating to BS1363 should be used.

As the colours of the wires in the mains lead of this appliance may not correspond with the coloured markings identifying the terminals in your plug, proceed as follows:-

- The wire which is coloured GREEN and YELLOW must be connected to the terminal which is marked with letter (E) or by the Earth symbol \perp or coloured GREEN and YELLOW.
- The wire which is coloured BLUE must be connected to the terminal which is marked with the letter (N) or coloured BLACK or BLUE.
- The wire which is coloured BROWN must be connected to the terminal which is marked with the letter (L) or coloured RED or BROWN.

If in doubt regarding the electrical connection of this appliance, consult a qualified electrician. Do not shorten the supply cable, the appliance may require removing for servicing.

N.B. Ensure that the plug socket is situated in an easily accessible place.

Installation

- Do not install this appliance if it is damaged in any way. Installing a damaged appliance may invalidate the guarantee.
- The water supply tap should be located in an adjacent cupboard so that it can be accessed after installation.
- Ensure the appliance is level by adjusting the feet as necessary. The dishwasher is equipped with an adjustable rear foot that can be raised or lowered by means of an adjustment screw, located in the centre of the kick plate.
- Only use the water inlet supplied with the appliance.
- If the water pressure is above 10bar a pressure relief valve should be used.
- After connecting the water supply, check to ensure there are no leaks.
- The water outlet can either be connected to a water drain or to a sink outlet spigot. This connection should be at a minimum of 50cm and a maximum of 110cm from the floor.



fig. 20

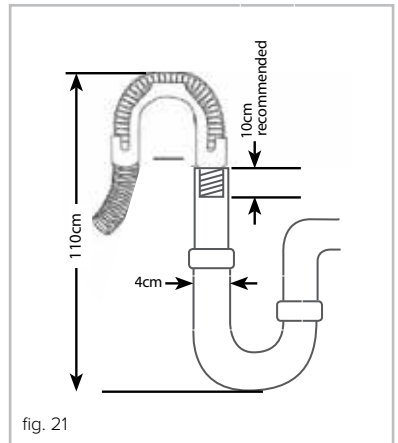

fig. 21

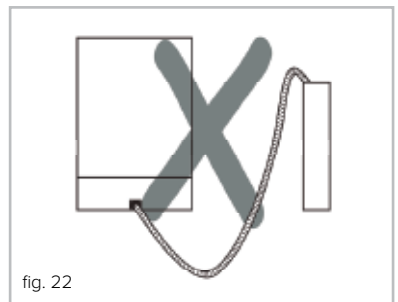

fig. 22

The drain hose should be no longer than 4m in length to ensure good performance from the dishwasher.

- To prevent siphoning, ensure that the water outlet is not pushed too far into the waste standpipe. The lowest part of the water outlet should be level with the bottom basket of the dishwasher.
- When connecting to the sink, ensure that the waste pipe runs higher than the level of the sink bowl to prevent siphoning.

Notes

Notes

Notes

THE PRODUCT FICHE (Spect)

Supplier's trade mark	CDA
Supplier's model	WF610BL
Capacity of dishwasher	15
The energy efficiency class	A++
Annual energy consumption in kWh per year (AEc) (280 Cycle) *	267
Energy consumption (E _i) (kWh per cycle)	0,94
Off-mode power consumption (W) (P _o)	0,05
Left-on mode power consumption (W) (P _i)	1,00
Annual water consumption in litres per year (AWc) (280 Cycle) **	2520
Drying efficiency class ***	A
Standard programme name ****	Eco 50 °C
Programme time for standard cycle (min)	162
Noise dB(A)	45

* Energy consumption **267** kwh per year, based on 280 standard cleaning cycles using cold water fill and the consumption of low power modes. Actual energy consumption will depend on how the appliance is used.

** Water consumption **2520** liters per year based on 280 standard cleaning cycles. Actual water consumption will depend on how appliance is used.

***Drying efficiency class **A** on a scale from G(least efficient) to A (most efficient).

**** The "**Eco 50 °C**" is the standard cleaning cycle to which the information in the label and the fiche relates. This programme is suitable to clean normally soiled tableware and it is the most efficient programme in terms of combined energy and water consumption.



Please contact our **Customer Care Department** for Service on the details below

Customer Care Department

The ICDAI Group Ltd. • Harby Road • Langar • Nottinghamshire • NG13 9HY
T : 01949 862 012 F : 01949 862 003 E : customer.care@cda.eu

