



HVG620 & HVG720 Gas Hob

Manual for Installation, Use and Maintenance

Important

The manufacturer cannot be held responsible for injuries or losses caused by incorrect use or installation of this product.

Please note that we reserve the right to invalidate the guarantee supplied with this product following incorrect installation or misuse of the appliance.

This appliance is not designed to be used by people (including children) with reduced physical, sensorial or mental capacity, or who lack experience or knowledge about it, unless they have had supervision or instructions on how to use the appliance by someone who is responsible for their safety.

Under no circumstances should any external covers be removed for servicing or maintenance except by suitably qualified personnel.

Appliance information:

Please enter the details on the appliance rating plate below for reference, to assist CDA Customer Care in the event of a fault with your appliance and to register your appliance for guarantee purposes.

Appliance Model	
Serial Number	

CE Declarations of Conformity:

This appliance has been manufactured to the strictest standards and complies with all applicable legislation, including Gas safety, Electrical safety (LVD) and Electromagnetic interference compatibility (EMC).

Parts intended to come into contact with food conform to EEC/89/109.

IMPORTANT INFORMATION FOR CORRECT DISPOSAL OF THE PRODUCT IN ACCORDANCE WITH EC DIRECTIVE 2002/96/EC.

At the end of its working life, the product must be taken to a special local authority waste collection centre or to a dealer providing appliance recycling services.

Disposing of a household appliance separately avoids possible negative consequences for the environment and health. It also enables the constituent materials to be recovered, saving both energy and resources. As a reminder of the need to dispose of household appliances separately, the product is marked with a crossed-out wheeled dustbin. 

Please note:

- Gas hobs become hot and remain hot during and immediately after use. Do not touch the pan stands, burners or hob spill tray until the appliance has been allowed to cool.
- Keep children away from the appliance when in use.
- After use, please ensure that the gas taps are in the 'Off' position.
- Ensure that the appliance is correctly adjusted for the type of gas available before installation.
- The use of a gas appliance produces heat and humidity in the room in which it is installed. Ensure that the room is well ventilated, either by the use of natural ventilation outlets (e.g. windows) or a ducted extractor.

- This hob (Class 3) has been designed for use only as a cooking appliance. Any other use (e.g. heating rooms) should be considered incorrect and potentially dangerous.
- These instructions are valid only for the countries of destination, the symbols of which appear on the cover and on the appliance .

Using your hob

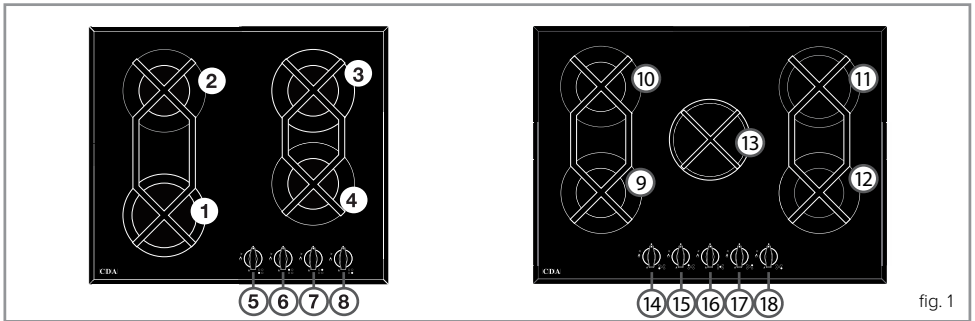

fig. 1

Gas burners:

1. Rapid burner 3.0kW
2. Left Semi-Rapid burner 1.75kW
3. Right Semi-Rapid burner 1.75kW
4. Auxiliary burner 1.0kW

Control panel:

5. Rapid burner control knob
6. Left Semi-Rapid burner control knob
7. Right Semi-Rapid burner control knob
8. Auxiliary burner control knob

Gas burners:

9. Auxiliary burner 1.0kW
10. Rapid burner 3.0kW
11. Rear semi-rapid burner 1.75kW
12. Front semi-rapid burner 1.75kW
13. Triple Ring / Wok burner 3.8kW

Control panel:

14. Auxiliary burner control knob
15. Rapid burner control knob
16. Triple Ring / Wok control knob
17. Rear semi-rapid burner control knob
18. Front semi-rapid burner control knob

Gas burners:

Gas flow to the burners is controlled by the control knobs (5, 6, 7 and 8 or 14, 15, 16, 17 and 18 on the diagram above). There are 3 positions shown on the control panel. Turning the control knob to the positions shown below achieves the following:

- Closed (OFF position)



Maximum position: Provides fast boiling function



Minimum position: Provides simmer function

The hob can be set to the desired position by turning the control knob through the adjustment range in an anti-clockwise direction.

This appliance is class 3

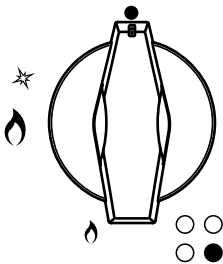

Control knob graphics

Igniting the Burners

The hob is fitted with a flame failure device. Flame failure devices operate by shutting off the supply of gas to the burner in the event that the flame is extinguished accidentally.

To ignite the burners, follow these instructions:

1. Lightly press the control knob down and turn the knob anticlockwise to the maximum position. Firmly press and hold down the control knob to begin the ignition process (a clicking sound will be heard). Hold down the control knob for a few seconds after ignition to allow the safety device to detect that the burner is lit.
2. Once the burner is lit, adjust the burner power to the required position.

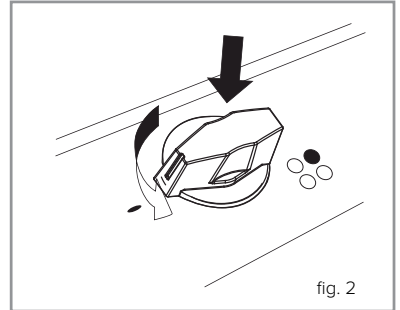

The hob is fitted with a flame failure device. Hold down the control knob for a few seconds after ignition to allow the safety device to detect that the burner is lit. Flame failure devices operate by shutting off the supply of gas to the burner in the event that the flame is extinguished accidentally.

Please note:

- The ignition device should not be operated for more than 15 seconds.

- If a burner does not ignite, or turns off accidentally, turn the control knob to the 'off' position, and wait for one minute before attempting to reignite the burner.
- If the burner does not ignite, repeat the ignition process with the burner at the minimum position.

Efficient use of your Hob

The hob is equipped with burners of different sizes, designed to accommodate most shapes and sizes of pan. For best results, only use pans with flat bottoms and choose an appropriate burner depending on the size of the pan. The most efficient use of the hob is shown below, where the pan and burner are correctly chosen.

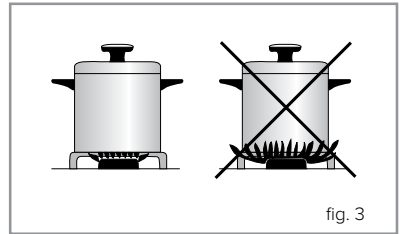

Ensure that the pans do not overlap the edge of the pan stand, or cover the control panel.

The table below shows the sizes of pan that should be used with each burner:

Burner Size	Minimum Pan Diameter (cm)	Maximum Pan Diameter (cm)
Auxiliary	12	14
Semi-Rapid	14	20
Rapid	18	24
Triple ring / Wok	24	26

Care and Maintenance

As the hob has a glass surface, you should use a nonabrasive cleaner. Any abrasive cleaner (including Cif) will scratch the surface and could erase the control panel markings. Glass can be effectively cleaned by simply using a dilute solution of water and mild detergent and drying to a shine with a clean cloth.

The enamelled parts of hobs are not suitable for cleaning in dishwashers; these should be washed by hand

IMPORTANT:

- Steam cleaners must not be used when cleaning this appliance.
- Ensure that all parts are correctly replaced after cleaning before attempting to use the hob.
- After removing the pan stands, ensure the rubber pads are in place on the base of the pan stand before repositioning the pan stands straight and level on the hob.

What to do if you smell gas:

1. Open doors and windows
2. Turn the gas supply off
3. Call TRANSCO on : 0800 111 999

Burner Size	Nominal Rating (kW)	Simmer Rating (kW)	LPG Flow Rate (l/h-1)	
			G30	G31
Auxiliary	1.0	0.6	72.8	71.5
Semi-Rapid	1.75	0.8	134.6	132.2
Rapid	3.0	1.2	218.8	214.8
Triple ring/wok	3.8	2.6	277	272

Total rated gas input : 7.5kW (HVG620), 11.3kW (HVG720)

Mains electrical voltage: 230 – 240Vac, 50Hz

Total rated electrical consumption: 1.1W

If your Hob is Not Working

1. Check that the mains supply has not been switched off.
2. Check that the fuse in the spur has not blown.
3. Ensure that the burner components are not excessively soiled as this can lead to ignition problems.

Mains Electricity Connection

THIS APPLIANCE MUST BE CONNECTED TO THE MAINS SUPPLY BY A COMPETENT PERSON, USING FIXED WIRING VIA A DOUBLE POLE SWITCHED FUSE SPUR OUTLET AND PROTECTED BY A 3A FUSE.

We recommend that the appliance is connected by a qualified electrician, who is a member of the N.I.C.E.I.C. and who will comply

with the I.E.T. and local regulations.

The wires in the mains lead of this appliance are coloured in accordance with the following code:

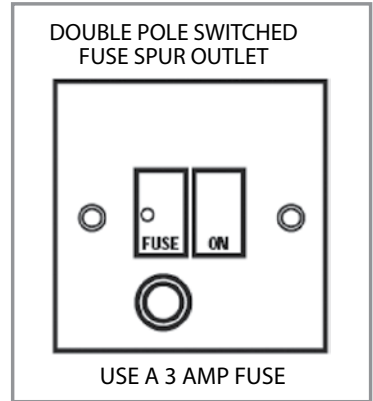

Green & Yellow = Earth, Blue = Neutral, Brown = Live.

As the colours of the wires in the mains lead for the appliance may not correspond with the coloured markings identifying the terminals connecting to the fuse spur, proceed as follows:

- The wire which is coloured green and yellow must be connected to the terminal marked E (Earth) or coloured green.
- The wire which is coloured blue must be connected to the terminal marked N (Neutral), or coloured black.
- The wire which is coloured brown must be connected to the terminal marked L (Live), or coloured red.

Note: Use a 3A Fuse

Assembly and electrical connection should be carried out by specialised personnel.

When installing this product we recommend you seek the help of another individual.

Gas Supply Requirements

IMPORTANT: THIS APPLIANCE SHOULD BE FITTED BY A GAS SAFE REGISTERED FITTER OR OTHER SUITABLY QUALIFIED PERSON.

- This installation must comply with the Gas Safety (installation and use) Regulations 1984.
- This appliance is category II2H3+ and is designed for use in the UK and Ireland. The installation must comply with the Gas Safety (installation and use) Regulations 1984.
- The CDA Group Ltd is not legally able to provide any assistance in the installation of gas appliances except to Gas Safe registered installers. Any Gas Safe registered fitter requiring help must provide their name, address and registration number. Information supplied will be validated before help is provided.
- In the event that this appliance is not installed in accordance with the above requirements, the appliance may be disconnected from the mains gas supply until any faults are rectified; this is a legal requirement.
- This appliance should be installed using 15mm copper pipe connected via a shut-off valve in an adjacent unit. The shut-off valve needs to be accessible in an emergency or for service purposes.
- This appliance must not be connected to a combustion gas

recovery scavenging system

- The connection to the gas supply must comply with all current regulations in force.
- We are not legally able to offer advice on the installation of gas appliances to non Gas Safe registered personnel.

Ventilation

All rooms require a window or equivalent (e.g. a door) which can be opened. Some rooms require a permanent vent in addition to a window (see below).

This unit must not be used in a room which is less than 5m³. The following table details the requirements based on the kitchen volume (L x W x H) in m³.

The above requirements also allow use of a gas oven and grill but if there are any other fuel burning appliances in the same room, consult the relevant British Standard (BS5440) or GAS SAFE document.

Room Volume (m ³)	Air Vent Required (cm ³)
5	100
6 to 10	50
6 to 11	No permanent vent required if a door opens to the outside
11 or more	None required

The above requirements also allow use of a gas oven and grill but if there are any other fuel burning appliances in the same room, consult the relevant British Standard (BS5440) or GAS SAFE document.

Natural Gas to LPG Conversion

This hob can be converted from natural gas to propane operation at a nominal inlet pressure of 37mbar, or butane operation at a nominal inlet pressure of 28/30mbar. This conversion must only be carried out by a competent person (i.e. a Gas Safe registered fitter).

Instructions to fit replacement injectors:

1. Disconnect the appliance from the gas and electrical supplies.
2. Remove burner components and pan supports.
3. Remove the injectors and replace with the corresponding injector as shown in the table below.

Required:

- 7mm AF nut spinner
- Replacement injectors
- LPG identity plate

Setting up minimum flow rates:

1. Remove the control knobs.
2. Turn on the LP gas supply, light the burners and turn the controls to the minimum position, as indicated by the small flame.
3. Insert a 2.5mm screwdriver into the hole at the top of the tap and turn the adjustment screw fully clockwise as shown in figure 6.

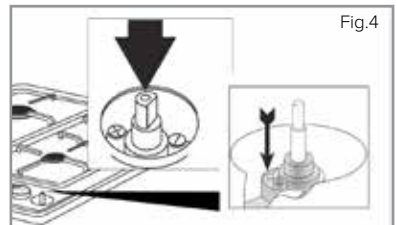

4. Turn the controls to maximum position then quickly to the minimum position - make sure the flame does not extinguish.
5. Replace the knobs.

LPG to Natural Gas Conversion

This hob can be converted from propane operation at a nominal inlet pressure of 37mbar or butane operation at a nominal inlet pressure of 28/30mbar to natural gas at 20mbar. This conversion must only be carried out by a competent person (i.e. a Gas Safe registered fitter).

Required:

- 7mm AF nut spinner
- Replacement injectors
- NG identity plate

Burner	LPG Injector	Natural Gas Injector
Rapid	86	115
Semi-Rapid	67	97
Auxiliary	49	72
Triple ring/Wok	100	135

Fitting the Hob

Unpacking the hob:

Take care not to lose or mishandle any parts.

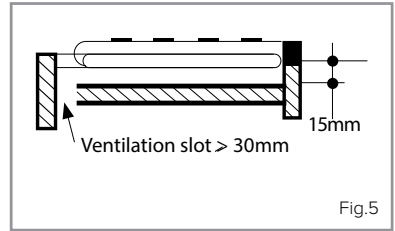

Fitting position of the hob:

This appliance must be installed a minimum of 50mm from any back wall and a minimum of 150mm away from any adjacent vertical surfaces, e.g. a tall cupboard end panel. This may be reduced to 100mm if the adjacent surface is resistant to fire (tiles or steel, for example). These dimensions are shown in Fig.5.

If fitting a cooker hood above the hob:

If a cooker hood is to be installed above the hob, the height of the hood above the hob must be at least 700mm (750mm is recommended) (Fig.6).

If the instructions supplied with the hood dictate that the hood must be installed at a height greater than 700mm, then that height is the minimum required.

Wall furniture requirements:

The minimum height of any cabinet immediately above the hob is 900mm.

The minimum height of any adjacent units (including light pelmets) is 400mm, unless they are manufactured from a material resistant to fire (steel, for example).

Notes:

- Do not position this appliance above a refrigeration unit. The heat generated may cause the refrigeration unit to fail.
- This appliance is designed to be installed into cabinet units capable of withstanding temperatures 65°C above ambient or greater (typically 80-90°C).
- If there is no oven to be built in below the hob it is recommended that, an isolation shelf should be fitted to protect the user from high temperatures. If the hob is to be installed above a working drawer, then a partition should be fitted to protect the contents and user from the heat generated during use.

This should be fitted at least 15mm below the hob. This panel should have a ventilation space at the rear of greater than 30mm as shown in fig. 5.

- Never place perishable foods in the cupboard below the appliance.

Energy Efficiency Information

A) Measurement and calculation methods

- The gas hob was CE approval according to the Gas Appliance Directives 2009/142/EC.
- The energy efficiency of this gas hob was tested and measured according to EN 30-2-1-1998+A1-2003+A2-2005.
- The semi-rapid burner and rapid burner were tested separately; the auxiliary burner is not required for test because its nominal heat input is less than 1.16kW.
- The energy efficiency of the gas burners and the hob were calculated according to COMMISSION REGULATION (EU) No. 66/2014.

B) Rational use of the energy and the appliance

- The gas hob is designed for domestic use only, please do not use for commercial.
- The gas hob is designed for use with gas (LPG and Natural gas), the combustion products contain carbon monoxide and carbon dioxide, the exhaust of combustion products is affecting our environment when reaching a certain level of CO and CO₂.
- To ensure the rational use of energy, please install the gas hob according to the specifications in clause 5, and please make sure you are using the correct diameter of pan for each burner.
- To ensure safe use, please read this instruction manual before use; please follow the installation, operation and maintenance guideline.

- To ensure the optimal life expectancy of the gas hob, please follow the operation and maintenance guideline strictly; please do not modify the appliance.
- Please contact your local after-sale service for repairing and exchanging of the components (such as gas valve, control knob) if necessary.
- The material of the gas hob is metal, please dispose of the gas hob in recycling when the gas hob comes to the end-of-life.
- The packaging materials of this appliance are recyclable, please make good use of waste materials.

Energy Efficiency Information				
Attribute	Symbol	Value		Units
Model Identification		HVG620	HVG720	
Annual Energy Consumption		Built in	Built in	
Time increase factor		4	5	
Fluid Dynamic Efficiency	EE _{Gas burner}	Aux:NA / SR:56.22 / SR:56.22 / R:53.95	Aux:NA / SR:56.22 / SR:56.22 / R:53.95 / Tr:55.45	%
Energy Efficiency Index	EE _{Gas hob}	55.46	55.46	%

E & O E. All instructions, dimensions and illustrations are provided for guidance only. CDA reserve the right to change specifications without prior notice.



Please contact our Customer Care Department for Service on the details below.

Customer Care Department • The CDA Group Ltd. • Harby Road • Langar • Nottinghamshire • NG13 9HY
T : 01949 862 012 F : 01949 862 003 E : customer.care@cda.eu W : www.cda.eu