



# HN9610 Induction Hob

Manual for Installation, Use and Maintenance

## Important

The CDA Group Ltd cannot be held responsible for injuries or losses caused by incorrect use or installation of this product. Please note that CDA reserve the right to invalidate the guarantee supplied with this product following incorrect installation or misuse of the appliance or use in a commercial environment.

This appliance is not designed to be used by people (including children) with reduced physical, sensorial or mental capacity, or who lack experience or knowledge about it, unless they have had supervision or instructions on how to use the appliance by someone who is responsible for their safety.

Under no circumstances should any external covers be removed for servicing or maintenance except by suitably qualified personnel.

### **Appliance information:**

Please enter the details on the appliance rating plate below for reference, to assist CDA Customer Care in the event of a fault with your appliance and to register your appliance for guarantee purposes.

Appliance Model	
Serial Number	

### **CE Declarations of Conformity**

This appliance has been manufactured to the strictest standards and complies with all applicable legislation, including Electrical safety (LVD) 2006/95/EC and Electromagnetic interference compatibility (EMC)

2004/108/EC. Parts intended to come into contact with food conform to 89/109/EC.

### **IMPORTANT INFORMATION FOR CORRECT DISPOSAL OF THE PRODUCT IN ACCORDANCE WITH EC DIRECTIVE 2002/96/EC.**

At the end of its working life, the product must be taken to a special local authority waste collection centre or to a dealer providing appliance recycling services.

Disposing of a household appliance separately avoids possible negative consequences for the environment and health. It also enables the constituent materials to be recovered, saving both energy and resources. As a reminder of the need to dispose of household appliances separately, the product is marked with a crossed-out wheeled dustbin. 

### **Precautions before use**

- Unpack the hob and all associated components, taking care not to lose or mishandle any parts.
- We recommend that the appliance is installed by a suitably qualified professional and connected to the electricity supply by a qualified electrician, who is a member of the N.I.C.E.I.C. and who will comply with the I.E.T. and local regulations.
- The appliance must be installed in a purpose-designed kitchen unit and worktop cut out as specified below.
- This hob (Class 3) has been designed for use only as a domestic cooking appliance. Any other use should be considered incorrect and therefore dangerous.

- Remove all labels and other packaging materials from the ceramic surface prior to use.
- Do not modify the appliance in any way as this will invalidate the guarantee and is potentially dangerous.
- The hob top is not designed for any use other than cooking: any other use (e.g. as a worktop) is potentially dangerous and will invalidate the guarantee.
- This appliance must be connected to fixed wiring and suitably earthed according to local regulations. Alternative connection, through a 13A plug or through an extension lead must not be used.
- This appliance must not be installed above a dishwasher, washing machine or tumble dryer as steam may damage the electronic components.
- The appliance is not intended to be operated by means of an external timer or separate remote control system.

## **Using the Appliance**

- Always switch cooking zones off after use.
- Take particular care when cooking with oils or fats that may ignite.
- Cooking pans and utensils and the hob itself become hot during use. Caution, risk of injury to people and pets both during and after use.
- Ensure no cable from any other appliance can come into contact with the hob top or pans during use.
- Magnetic objects (such as credit cards or portable

electronic devices) must not be placed near the hob during use.

- Do not place any metal object (other than suitable pans) on the hob.
- Never cover the hob with any cloth or other cover. This may become hot and create a fire hazard.
- This appliance can be used by children aged from 8 years and above and persons with reduced physical, sensory or mental capabilities or lack of experience and knowledge if they have been given supervision or instruction concerning use of the appliance in a safe way and understand the hazards involved.
- Children shall not play with the appliance.
- Cleaning and user maintenance shall not be made by children without supervision.
- Metal objects such as knives, forks, lids etc. should not be placed on the hob as they may become hot.

### **Precautions to protect the hob**

- Use of damaged pans or those with raw cast iron bottoms may damage the hob ceramic glass.
- Abrasive materials such as scouring cleaners and grits may damage the ceramic glass.
- Avoid dropping objects onto the ceramic glass.
- Take care not to strike the edges of the hob with saucepans.

- Ensure that ventilation (as specified under installation instructions) remains free from obstructions.
- Do not place empty saucepans on the hob.
- Sugar, synthetic plastics or aluminium foil must not be allowed to come into contact with the heating zones; these may cause permanent damage to the ceramic glass. If these should accidentally fall onto the hob, turn it off immediately and carefully remove them. Take care not to burn yourself.
- Never place any hot items on the control panel.
- **Warning: Danger of fire:** Do not store items on the cooking surface.
- If a drawer is located below the hob, ensure a horizontal divider is installed leaving a minimum gap of 2cm above it for hob ventilation, and protecting the drawer contents from striking the hob. The divider must be made of material capable of withstanding 65°C above ambient temperature.
- Never place inflammable items or materials in a drawer or cupboard below the hob.

### **Precautions in the event of an appliance fault**

- If a fault is noticed, switch off the appliance and turn off the electricity supply.
- **Warning:** If the ceramic glass is broken or cracked do not use the appliance, turn off the electricity supply to avoid the possibility of electric shock. Contact CDA Customer Support.

- There are no user-serviceable parts inside the appliance; all repairs must be performed by a suitably qualified service engineer or similar.
- See the “Troubleshooting” section in this manual.

### **Other precautions**

- Ensure that each pan is centred on its cooking zone: The pan base must cover as much of the cooking zone as possible.
- Do not use aluminium or plastic containers: they could melt onto hot cooking zones.
- The use of incorrect cookware or any induction adaptor plate designed for non-magnetic cookware is outside the manufacturer’s specifications so will invalidate the guarantee. The manufacturer cannot be held responsible for any damage to the hob or consequential damages as a result of such use.
- Never try to extinguish a fire with water, but switch off the appliance and then cover the flame with a lid, fire blanket or similar.

---

## **FOR THOSE WITH HEART PACEMAKERS OR ACTIVE IMPLANTS:**

The function of this hob conforms to current electromagnetic interference standards and thus is in total compliance with legal requirements (2004/108/CE directives).

To avoid interference between your hob and a pacemaker, your pacemaker must be designed and programmed in compliance with the regulations that apply to it. As such, CDA guarantee only that our product is compliant.

With regard to the compliance of the pacemaker or any potential incompatibility, you should obtain information from the manufacturer or your attending physician.



# Using Your Hob

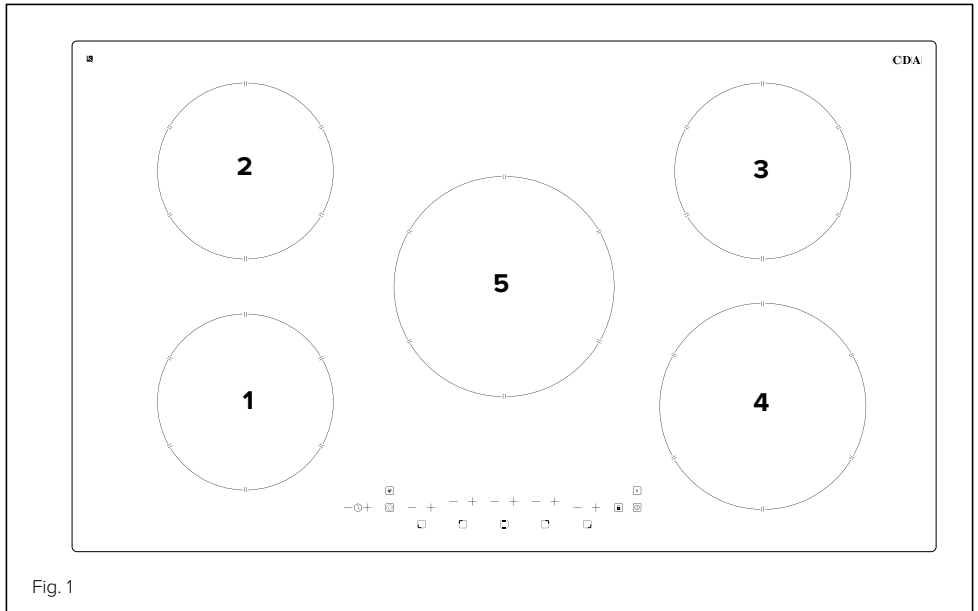

## Zones:

- 1: Front left 1.85kW (3.0kW boost) 180mm
  - 2: Back left 1.85kW (3.0kW boost) 180mm
  - 3: Back right 1.85kW (3.0kW boost) 180mm
  - 4: Front right 2.1kW (3.7kW boost) 210mm
  - 5: Centre 2.1kW (3.7kW boost) 210mm
- (See inside back cover for full details)

# Control Panel

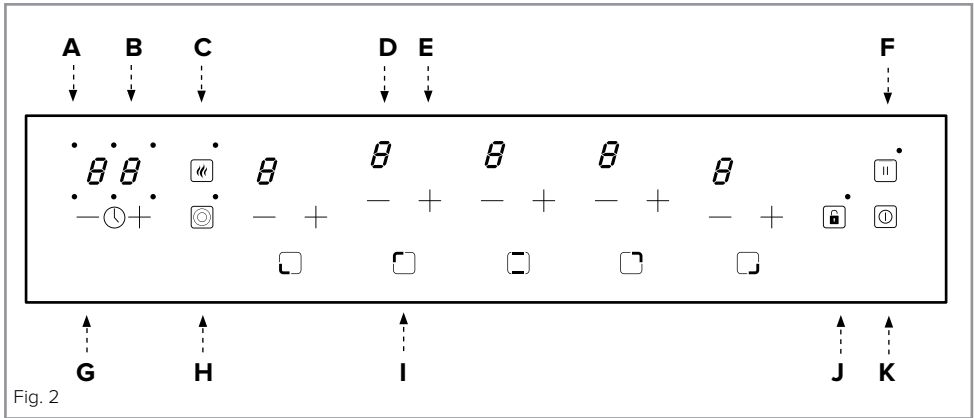

Fig. 2

## Control panel

- |                           |                    |
|---------------------------|--------------------|
| A: Zone timer indicator   | G: Timer keys      |
| B: Timer display          | H: Booster key     |
| C: Special programmes key | I: Zone indicators |
| D: Zone displays          | J: Key lock        |
| E: Zone power level keys  | K: Power key       |
| F: Pause key              |                    |

Power level	Type of cooking
0	Switched off
1/2	Melting (butter/chocolate) or keeping food warm
2/3	Keeping food hot or to heat small quantities of liquid
3/4	Heat larger quantities of liquid (sauces etc.)
4/5	Slow boiling, e.g. spaghetti, soups, stews, potatoes
6/7	Gentle frying
7/8	Browning meats, frying fish, omelettes
9	Fast frying steaks

# Cooking on Induction

The principle of induction cooking is based on magnetic effect.

When you put your cookware on an induction zone and switch it on, the electronic boards in the hob produce induced currents in the base of the cookware and instantly raise its temperature. This heat is then transferred to the food inside the cookware.

The best cookware to use with induction cooking has thick flat bases, as the heat will be better distributed so cooking more evenly.

Most cookware is compatible with induction cooking. There are three ways to check the suitability of your cookware:

1. Use a magnet to see if the base of the pan is magnetic: if the magnet sticks, then the cookware is compatible.
2. Place the pan on one of the cooking zones switched on to power level 4: If the display remains on, then the cookware is compatible. If the display flashes, the cookware cannot be used on an induction hob.
3. Check the instructions or packaging of the pans for the symbols indicating suitability for use with induction.

# Using Your Hob

## To switch the hob on

To switch the power on, touch and hold the  key for approximately two seconds. The hob will beep and all five zone displays will show zero.

**Please note: If a power level is not set within ten seconds, the hob will switch off automatically.**

## To set the power level

There are power level keys for each individual zone which allow you to set the power level by touching the “+” or “-” keys for the zone required.

To turn a zone on, either touch the “+” key to set the power level at an initial setting of “4”, or touch the “-” key to set the power level at an initial setting of “9”.

To increase the power level from 1 (minimum) toward 9 (maximum), touch the “+” key. To decrease the power level touch the “-” key.

## To turn the power off

To switch off a single zone, touch the “+” and “-” keys together for the zone no longer required. This will set the power level to zero.

Alternatively, touch the “-” key until the zone display shows zero.

When all the zones are at zero, the hob will switch off automatically after approximately ten seconds.

Alternatively, to switch off the hob immediately, touch and hold the  key for approximately two seconds.

## Special Programmes

The hob has two optional preset programmed heating levels for each of the zones.

### 42°C setting

- Touch the “Special Programmes” key  so the special programmes control light illuminates.
- Then touch either the “+” or “-” key for the zone you wish to maintain the 42°C temperature.

To cancel the special programme at any time, touch the “-” key for that zone.

### 70°C setting

- Touch the “Special Programmes” key  **twice** so the special programmes control light **flashes**.
- Then touch either the “+” or “-” key for the zone you wish to maintain the 70°C temperature.

To cancel the special programme at any time, touch the “-” key for that zone.

## Booster

The hob is equipped with a dual level booster function, enabling higher power levels than the maximum for approximately five minutes.

### Level 1

- Touch the “Booster” key  so the booster control light illuminates.
- Then touch either the “+” or “-” key for the zone you wish to boost.  
The display for that zone will show “**P**”.

To cancel the booster at any time, touch the “-” key for that zone.

## Level 2

- Touch the “Booster” key  **twice** so the booster control light **flashes**.
  - Then touch either the “+” or “-” key for the zone you wish to boost. The display for that zone will show “**11**” alternating with “**!!!**”.
- To cancel the booster at any time, touch the “-” key for that zone.

**Note:** The hob is fitted with a power management system to limit the total power used. When using the booster on one or more zones this function may limit the power being used by other zones.



## **Auto-heat**

Every zone is equipped with an auto-heat function, which reduces the warming up time for the zone. To turn on the auto-heat function:

- Set the power level for that zone to “9”.
- Then touch the “+” key for that zone again so its display alternates between “9” and “A”.
- Within five seconds, select the power level required. The display will alternate between the set power level and “A” for a preset period of time. When auto-heating has finished the power will reduce to the level set.
- If no final power level is set, the auto-heat is switched off and the zone will remain on power level “9”.

## **Pause**

The hob is equipped with a pause function which pauses cooking temporarily without switching the power off completely.

- To pause the hob, touch the “Pause” key , the hob displays “11” in all the zone displays.
- To restart cooking, touch the “Pause” key  again.

## Timer

The hob is equipped with a timer that allows finish times to be set for the end of cooking on any combination of zones, between a minimum of one minute and a maximum of 99 minutes. This timer can also be used as a minute minder.

The timer display is surrounded by six indicators:

The middle front one represents the minute minder and the other five are “Zone timer indicators”, representing the individual zones.

### To set the timer

To set a finish time for a heating zone, first it is necessary to turn on that zone as above. Then:

- Touch both the timer “+” and “-” keys together. The timer control light function will switch on.
- Touching both the timer “+” and “-” keys together again several times will allow you to cycle through the available control areas (one for each heating zone in use and the minute minder one).
- While one of the “Zone timer indicators” is flashing you can set the timer for that zone using the “Timer keys”.
  - Touch “+” repeatedly to start at 0 minutes and work upward, note that it will scroll more quickly if you just hold your finger on it.
  - Alternatively, if you touch the “-” key first the setting will start at 30 minutes.

- After approximately five seconds, the “Zone timer indicator” will stop flashing and the countdown will start.
- The timer display will show the minutes remaining.

At the end of the timer, the selected zone will switch off and the hob will beep for approximately one minute. To switch off the beep touch either of the “timer keys”.

### **To cancel the timer**

- Touch both the timer “+” and “-” keys together several times until the “Zone timer indicator” for the timer zone you wish to cancel flashes. That timer zone is then in “setting” mode.
- Use the timer “-” key to reduce the time outstanding to zero.
- The timer will remain in setting mode until approximately five seconds, after your last key touch.

**Please note: Cancelling the timer will not switch off the zone. You should switch the zone off manually if required.**

**Please note: the power level can be adjusted during the countdown using the “+” or “-” keys.**



# Key Lock

The hob is equipped with a key lock to lock the controls. This can be used when the hob is off or during cooking.

## **To switch on the key lock**

Touch the  key for approximately two seconds until the LED above the key lock key illuminates and the hob beeps to confirm the key lock is switched on.

## **To switch off the key lock**

Touch the  key for approximately two seconds until the LED above the key lock key switches off and the hob beeps to confirm the key lock is switched off.

## **Use of the key lock when the hob is off**

The key lock remains set when the hob is turned off, so still must be cancelled next time the hob is turned on.

## **Use of the key lock when the hob is in use**

The key lock LED is illuminated to confirm that the key lock is switched on and no adjustments can be made to any of the zones or the timer. It is possible to switch off the hob using the  key when the key lock is on, for safety reasons.

## **Residual heat indicators**

The hob is equipped with residual heat indicators to warn when any of the zones are still hot to the touch after cooking. An “**H**” will show in the relevant zone display after cooking until the zone is at a safe temperature to touch.

In the event of a power cut, the residual heat indicators will illuminate after the power supply is restored. However, when there is no power supply to the hob the residual heat indicators will not work, so extra care must be taken.

### **Please note:**

You should avoid touching the zones when the hob is in use, or when an “**H**” is showing on the zone display.

## **Small object safety**

Anything left on the control panel (e.g. cutlery or towels) will cause the hob to switch off automatically and “Er03” to show on the display.

## **Pan detection**

The hob is equipped with a sensor that will advise when the pan is removed from the zone, or is unsuitable for use on induction hobs. The zone display will show “**u**” alternating with the power level until a suitable pan is placed on the zone. The zone will switch off after approximately one minute if no suitable pan is placed on the zone.

# Efficient Use of Your Hob

The hob is equipped with zones of different sizes, designed to accommodate most shapes and sizes of pan. For best results, only use pans with flat bottoms and choose an appropriate zone depending on the size of the pan. The most efficient use of the hob is shown below, where the pan and zone are correctly chosen.

Use pan lids where possible to minimize the energy usage of your appliance.

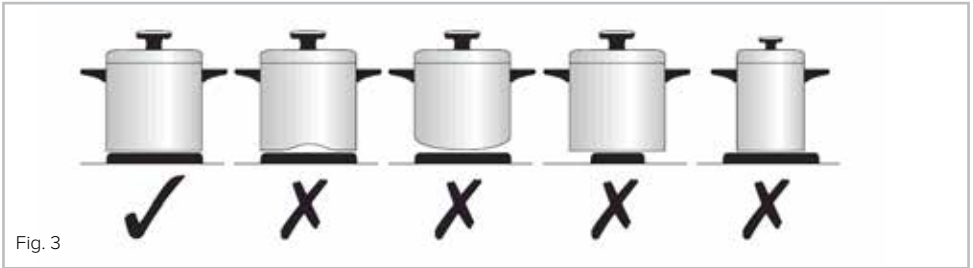

Fig. 3

Zone Size	Minimum Pan Size (cm)	Maximum Pan Size (cm)
180mm	10	20
210mm	11	24

It is very important that the pans used on the hob are made of a suitable material and have the correct type of base. The base of the pan must be clean before use to prevent any scratches on the hob top.

# Care and Maintenance

Always disconnect the appliance from the power supply before undertaking any cleaning or maintenance.

## Important:

- Steam cleaners must not be used when cleaning this appliance. You should use a non-abrasive cleaner to clean the hob top. Any abrasive cleaner (including Cif) will scratch the surface and could erase the control panel markings.
- Sugar and starch can cause permanent damage to the surface of the hob. Wipe away any spillages immediately.

Types of residues	Clean with	Cleaning advice
Light	Cleaning sponge and soft cloth	Wipe over the zone to be cleaned with a sponge and hot water, and then wipe off with a soft dry cloth.
Accumulated baked-on stains/dirt, sugar spills or melted plastics	Cleaning sponge or glass scraper and soft cloth	Wipe over the zone to be cleaned with a sponge and hot water, using a ceramic scraper to remove any large marks or stains and then wipe off with a soft dry cloth.
Rings and hard water residues	White vinegar and soft cloth	Pour a small amount of warm white vinegar onto the stain, leave it to stand, and then wipe off with a soft dry cloth.
Shiny metallic streaks	Cleaning agent for vitroc ceramic glass etc.	Use specialist vitroc ceramic glass cleaner (preferably one with silicone for its protective properties)

## If your hob is not working:

1. Check that the zone is switched on.
2. Check that the mains supply has not been switched off.
3. Check that the fuse in the spur has not blown.

In the event of a fault with the hob, please advise CDA Customer Care of any fault code shown on the display

## Contact CDA Customer Care

**A:** Customer Care Department, The CDA Group Ltd, Harby Road,  
Langar, Nottinghamshire, NG13 9HY

**T:** 01949 862 012    **F:** 01949 862 003

**E:** customer.care@cda.eu    **W:** www.cda.eu

# Troubleshooting

## On first use

You observe that	Possible Causes	What should you do?
The hob does not work and the lights on the control panel do not switch on.	The key lock is set	Touch and hold the key lock key to turn the key lock off.
Installation blows a fuse.	The electrical connection of the hob is incorrect	Check that it is set up properly (see the Electrical Connection section)

## On switching on

You observe that	Possible Causes	What should you do?
The hob does not work and the lights on the control panel do not switch on.	Electrical connection fault.	Check the power supply.
	Protection circuit breaker or fuse has tripped.	Replace the fuse or reset the circuit breaker.
	A small object, grease or water is on one of the control keys.	Check the control keys are clean and no objects are on them.

## In use

You observe that	Possible Causes	What should you do?
One or all of the zones cuts out.	The safety system has cut out.	Leave hob to cool then try it again
	A cooking zone has been running for a very long time	Switch it on again (if required).
	One or more control keys are covered.	Clear any objects and clean liquid from the control area.
	A pan has boiled dry and is overheating.	Remove the pan in question.
The fan continues to run after the hob is switched off.	This is not a fault, the cooling system is working correctly.	Nothing.
“U” flashes on the zone display.	The cookware used is not suitable for induction.	See page 8 for information on cooking on induction
	There is no pan on the cooking zone.	Place a suitable pan on the cooking zone.
	The bottom diameter of the pan is too small.	Place a larger pan on the cooking zone.
“E” shows on the zone display.	The electronic system is defective.	Contact CDA Customer Care for advice.
“Er03” shows on the zone display.	One or more control keys are covered.	Clear any objects and clean liquid from the control area.
“E2” shows on the zone display.	The hob is overheated.	Let it cool down, then try it again.
“Er47” shows on the zone display.	The hob is not connected to the network.	Check the connection and reconnect the hob.
“E8” shows on the zone display.	The ventilation air inlet is blocked.	Clear the ventilation air inlet.
“U400” shows on the zone display.	The hob is not connected to the network.	Check the connection and reconnect the hob.

**IMPORTANT - PLEASE NOTE:** In the event of any breakage, crack or cracking – even minimal – of the vitroceramic glass, immediately disconnect your appliance to prevent a risk of electric shock and contact CDA Customer Care.

# Fitting the Hob

## **Unpacking the hob:**

Take care not to lose or mishandle any parts.

## **Fitting position of the hob:**

This appliance must be installed a minimum of 50mm from any back wall and a minimum of 180mm away from any adjacent vertical surfaces, e.g. a tall cupboard end panel. This may be reduced to 100mm if the adjacent surface is resistant to fire (tiles or steel, for example). These dimensions are shown in Fig. 5.

## **Ventilation requirements:**

This appliance must be installed to allow air to flow freely to the air intake, from the air outlet and in the base and run of units into which it is installed (Fig 3). An air gap of 20mm is recommended immediately below the hob.

Failure to allow sufficient ventilation could cause damage to the hob and constitutes incorrect installation, which is not covered by the warranty.

## **Notes:**

- This could be a simple slot cut out of the plinth, or a dedicated ventilation grille.
- The furniture top rail should not be fitted to the unit. This allows the induction hob to exhaust air into the kitchen space.
- The recommended ventilation sizes are for guidance only.

### **If fitting a cooker hood above the hob:**

If a cooker hood is to be installed above the hob, the height of the hood above the hob must be at least 600mm (650mm is recommended) (Fig. 4). If the instructions supplied with the hood dictate that the hood must be installed at a height greater than 600mm, then that height is the minimum required.

### **Wall furniture requirements:**

The minimum height of any cabinet immediately above the hob is 900mm. The minimum height of any adjacent units (including light pelmets) is 400mm, unless they are manufactured from a material resistant to fire (steel, for example).

### **Notes:**

- Do not position this appliance above a refrigeration unit. The heat generated may cause the refrigeration unit to fail.
- This appliance is designed to be installed into cabinet units capable of withstanding temperatures of 65°C or greater above ambient temperature.
- Never place perishable foods, soft items such as tea towels, cleaning products or flammable items in the cupboard or drawer below the appliance.
- If an oven is to be installed below the hob, the thermal safety system on the hob will not allow the hob to be used at the same time as a pyrolytic programme on the oven.



- 
- The hob is equipped with an anti-overheating safety device that can be activated if the hob is installed over an oven that is not sufficiently ventilated. In the event that this occurs, the zone display will show “**E2**”. We recommend that you increase the ventilation of the hob by creating an opening in the side of the cabinet (8cm x 5cm).
  - **WARNING:** Do not use inappropriate child protectors or railings with this hob. The use of these devices may lead to accidents.

# How to Install the Hob

## Overall dimensions of the hob:

Width: 880mm Depth: 520mm

## Worktop cut-out dimensions:

Width: 810mm Depth: 490mm

1. Make the required hole in the worktop. Before doing this, you must check the instructions supplied with any cooker hood to ensure that you will have the required clearance. The cut-out (Fig. 5) shows a 60mm gap from the wall to the cut-out edge. The distance from the hob, when fitted, to the back wall is 50mm.

If a splashback/worktop upstand is to be fitted, take this into account when cutting the hole. The minimum distance that the hob should be positioned away from the rear wall or splashback is 50mm.

2. Fix the foam seal underneath the appliance by following the outline of the worktop upon which the hob will rest. This ensures an airtight seal with the worktop. Do not use silicone type sealant.

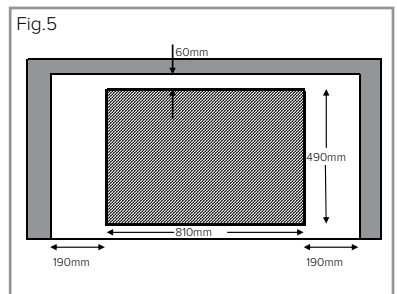
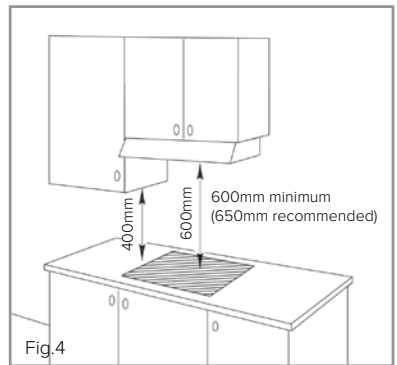
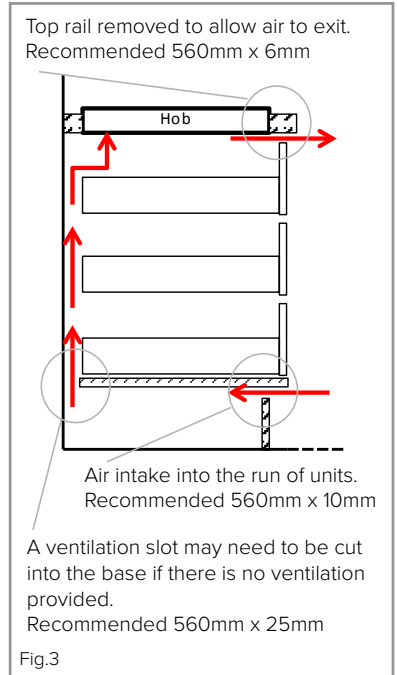

# Mains Electricity Connection

## **Warning! this appliance must be earthed**

We recommend that the appliance is connected by a qualified electrician, who is a member of the N.I.C.E.I.C. and who will comply with the I.E.T. and local regulations.

This hob is intended to be connected to permanent, fixing wiring by a double pole switch, having a contact separation of at least 3mm in all poles. The switch must be positioned no further than 2m from the appliance.

### **Please note:**

- The mains cable must only be replaced by a qualified electrician or service engineer and must be of equivalent or better rating (i.e. 2.5mm<sup>2</sup>, HO5V2V2/F).
- The current rating of the fuse or circuit breaker protecting this appliance should be marked on the socket outlet.
- Assembly and electrical connection should be carried out by specialised personnel.
- When installing this product we recommend you seek the help of another individual.
- Protection against live parts must be ensured after installation.
- Connection data is printed on labels on the hob casing close to the connection box.
- As the appliance is not fitted with an accessible plug, a means of disconnection from the power supply must be included in the fixed installation, in accordance with the installation regulations.

- The inlet cable must be positioned so that it does not touch any of the hot parts of the hob or oven.

**Caution**

- This appliance must only be connected to a 230V ~ 50Hz network.
- Observe the connection diagram.
- The connection box is located underneath at the back of the hob casing. To open the cover use a medium screwdriver. Insert it in the slits to open the cover.

Appliance electrical rating: 7400W

The following diagram shows the mains connection:

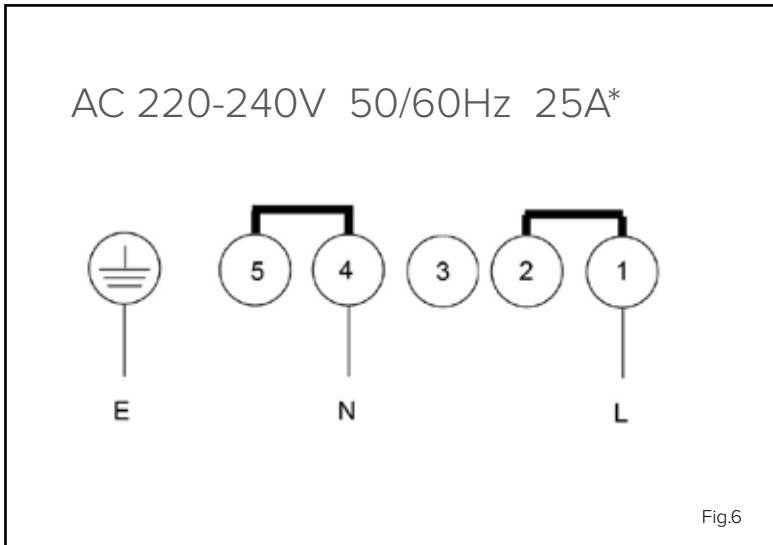

Fig.6

\* Calculated using the diversity factor following the standard EN 60 335-2-6.

---

**Any service call arising from incorrect installation may result in a charge.**

**CDA and its representatives cannot be held responsible for any matters resulting from incorrect connection, or related to either the absence of an earth connection or a faulty earth connection.**

---

NOTES:

<b>Energy Efficiency Information</b>			
<b>Attribute</b>	<b>Symbol</b>	<b>Value</b>	<b>Units</b>
CDA model		HN9610	
Type of hob		Built in	
Number of cooking zones and/or areas		5	
Heating technology (induction cooking zones and cooking areas, radiant cooking zones, solid plates)		Induction cooking zones	
For circular cooking zones or area: diameter of useful surface area per electric heated cooking zone, rounded to the nearest 5mm	∅	FL:18.0 / FR:21.0 / RL:18.0 / RR:18.0 / Centre:21.0	cm
For non-circular cooking zones or areas: length and width of useful surface area per electric heated cooking zone or area, rounded to the nearest 5mm	L W	NA	cm
Energy consumption per cooking zone or area calculated per kg	EC <sub>Electric cooking</sub>	FL:175.4 / FR:177.1 / RL:175.4 / RR:175.4 / Centre:164.8	Wh/kg
Energy consumption for the hob calculated per kg	EC <sub>Electric hob</sub>	173.6	Wh/kg

\* Calculated according to the method of measuring performance (EN 60350-2).



Please contact our Customer Care Department for Service on the details below

**Customer Care Department • The CDA Group Ltd. • Harby Road • Langar • Nottinghamshire • NG13 9HY**  
**T : 01949 862 012 F : 01949 862 003 E : [customer.care@cda.eu](mailto:customer.care@cda.eu) W : [www.cda.eu](http://www.cda.eu)**