



EIN60

Extractors

Installation, use and maintenance



Important

The manufacturer cannot be held responsible for injuries or losses caused by incorrect use or installation of this product. Please note that the manufacturer reserves the right to invalidate the guarantee supplied with this product following incorrect installation or misuse of the appliance or use in a commercial environment.

This appliance is not designed to be used by people (including children) with reduced physical, sensorial or mental capacity, or who lack experience or knowledge about it, unless they have had supervision or instructions on how to use the appliance by someone who is responsible for their safety.

Under no circumstances should any external covers be removed for servicing or maintenance except by suitably qualified personnel.

Appliance information:

Please enter the details on the appliance rating plate below for reference, to assist CDA Customer Care in the event of a fault with your appliance and to register your appliance for guarantee purposes.

Appliance Model	
-----------------	--

Serial number	
---------------	--

CE Declarations of Conformity:

This appliance has been manufactured to the strictest standards and complies with all applicable legislation, including Gas safety, Electrical safety (LVD) and Electromagnetic interference compatibility (EMC).

IMPORTANT INFORMATION FOR CORRECT DISPOSAL OF THE PRODUCT IN ACCORDANCE WITH EC DIRECTIVE 2012/19/EU.

At the end of its working life, the product must be taken to a special local authority waste collection centre or to a dealer providing appliance recycling services.

Disposing of a household appliance separately avoids possible negative consequences for the environment and health. It also enables the constituent materials to be recovered, saving both energy and resources. As a reminder of the need to dispose of household appliances separately, the product is marked with a crossed-out wheeled dustbin. 

Please note:

- Under no circumstances should the extractor be connected to any gas ventilation system, flue system or hot air ducting system.
- Do not vent the extractor into an attic or loft space.
- Only house the extractor in rooms with adequate ventilation. Remember that the extractor is powerful and whatever air is extracted needs to be replaced.

-
- Do not tile the extractor in. It should be removable for service or maintenance.
 - Do not use silicone sealant to secure the hood to the wall.
 - You must be able to isolate the extractor from the mains electrical supply after installation.
 - This extractor has been designed to be used in a room with a volume of less than 36 m³.
 - Steam cleaners must not be used when cleaning this appliance.
 - The performance of your extractor will vary depending on a number of factors. These include: type of extraction, length of ducting (see page 14), room volume, ventilation available and cleanliness of the filters.

Using your extractor

For best performance, you should switch on the extractor 15 minutes before starting to cook and leave it to run for approximately 15 minutes after the end of cooking.

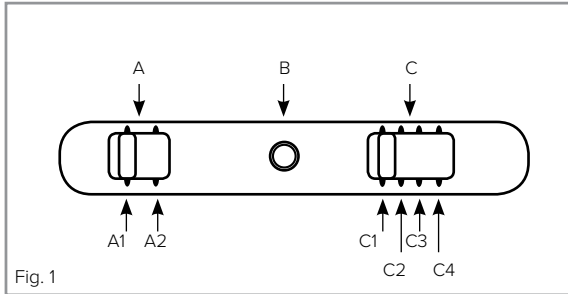

Control Panel

A – Light switch

B – Power indicator light

C – Power switch

To switch the extractor light on or off

- Slide the light switch to position A1 for off, or A2 for on.

To switch on the extractor, or change the motor speed

- Slide the power switch to the position required dependent on the speed you require.

To switch the extractor off

- Slide the power switch to position C1 for off.

Care and maintenance

IMPORTANT : DO NOT PERFORM MAINTENANCE OR CLEANING OF THE EXTRACTOR WITHOUT FIRST SWITCHING OFF THE ELECTRICITY SUPPLY.

Cleaning

You should use a nonabrasive cleaner. Any abrasive cleaner (including Cif) will scratch the surface and could erase the control panel markings.

You can clean your extractor effectively by simply using a dilute solution of water and mild detergent and drying to a shine with a clean microfibre cloth.

Cleaning the (rectangular) grease filter

The grease filter captures grease particles in the air, so is therefore subject to clogging depending on the frequency of use of the appliance.

In order to prevent fire hazard it is recommended to clean the grease filter at a maximum of 2 month intervals by carrying out these instructions:

Depending on model, you may have either acrylic or aluminium grease filter(s).

Acrylic grease filter:

1. Remove the cover panel by pushing the fixing clips up and then lifting the panel forwards.
2. Remove the filter retaining wires from the cover panel.
3. Remove the grease filter and wash by hand in a lukewarm solution of water and mild detergent. Once clean squeeze the grease filter but DO NOT wring it out. Clean the filter holder using a dilute solution of water and mild detergent or with a damp cloth. Allow the grease filter to dry completely before reassembling the extractor.
4. Replace the grease filter in the cover panel and reattach the filter retaining wires.
5. Replace the cover panel by inserting the lugs on the upper side in the extractor, and then refasten the fixing clips on the lower side.

Aluminium grease filters:

1. Remove the filters from the cooker hood and wash in a solution of warm water and neutral liquid detergent, leaving to soak.
2. Rinse thoroughly with warm water and leave to dry.
3. The filters may alternatively be washed in the dishwasher. The aluminium panels may alter in colour after several washes in a dishwasher. This is not a fault and is not cause for replacing the panels.

Changing the (circular) charcoal filter (re-circulating only):

To ensure best performance of your extractor, you should replace the charcoal filters every four to six months, depending on use.

Please note the charcoal filter cannot be washed.

To attach a new charcoal filter, follow the steps below:

1. Remove the cover panel (acrylic filter model) or grease filter (aluminium filter model) as described above.
2. Place the charcoal filter on the centre of the motor support, and once firmly located turn the charcoal filter clockwise 90° until the charcoal filter locks into position.
3. Replace the cover panel or grease filter that has been removed.

Changing the light

ENSURE THAT THE POWER TO THE EXTRACTOR IS SWITCHED OFF AT THE MAINS. DO NOT CHANGE THE LIGHT BULB IMMEDIATELY AFTER USE AS THE BULB WILL BE HOT. ALLOW IT TO COOL BEFORE REMOVING IT.

Remove the cover panel as described on page 7. Unscrew the light bulb and replace the light with the required light bulb (4W max LED, SES). Finally, replace the cover panel.

- Do not touch bulbs or adjacent areas during or straight after prolonged use of the lights.
- The light is designed for use during cooking and not for general room illumination. Extended use of the light can reduce the life span of the bulb.
- Bulb replacement is not covered by the guarantee.
- Only use bulbs recommended for your extractor. Do not fit bulbs of a higher power rating. Bulbs of a lower power rating may be adequate for use, generally last longer and use less energy.
- Spare bulbs are available from CDA Customer Care or from your local DIY shop.

Mains electricity connection

THIS APPLIANCE MUST BE CONNECTED TO THE MAINS SUPPLY BY A COMPETENT PERSON, USING FIXED WIRING VIA A DOUBLE POLE SWITCHED FUSED SPUR OUTLET AND PROTECTED BY A 3A FUSE.

We recommend that the appliance is connected by a qualified electrician, who is a member of the N.I.C.E.I.C. and who will comply with the I.E.T. and local regulations.

The wires in the mains lead of this appliance are coloured in accordance with the following code:

BLUE = NEUTRAL, BROWN = LIVE.

As the colours of the wires in the mains lead for the appliance may not correspond with the coloured markings identifying the terminals connecting to the fused spur, proceed as follows:

- The wire which is coloured blue must be connected to the terminal marked N (Neutral), or coloured black.
- The wire which is coloured brown must be connected to the terminal marked L (Live), or coloured red.

NOTE: USE A 3A FUSE

Assembly and electrical connection should be carried out by competent personnel.

When installing this product we recommend you seek the help of another individual.

IMPORTANT: THIS APPLIANCE IS A CLASS II APPLIANCE (DOUBLE INSULATED) AND IS NOT INTENDED TO BE EARTHED. DO NOT FIT AN EARTH LEAD TO THIS EXTRACTOR.

Do not mount the isolation switch behind the chimney section. It is a requirement that you must be able to isolate the extractor from the mains electrical supply after installation.

This appliance is intended to be connected to the mains electrical supply by means of an isolation switch and fused spur and is intended to be protected by a 3A fuse. The use of a 13A fuse can cause damage to the internal wiring in the event of a fault, and may also invalidate the warranty.

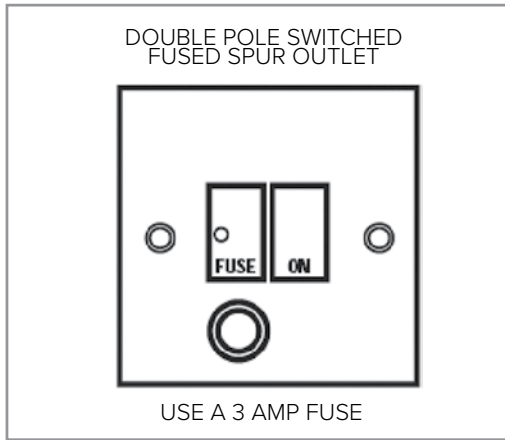

Electrical information

Mains electrical voltage: 230 – 240Vac.

Total rated power consumption: 49W

Troubleshooting

If your extractor is not working:

1. Check that the mains supply has not been switched off.
2. Check that the fuse in the spur has not blown.

Contact CDA Customer Care

A : Customer Care Department, The CDA Group Ltd, Harby Road,
Langar, Nottinghamshire, NG13 9HY

T : 01949 862 012 **F** : 01949 862 003 **E** : customer.care@cda.eu

W : www.cda.eu

Installation - preparation

When the extractor is to be installed above an electric hob, the minimum distance between the hob and extractor must exceed 600mm (650mm is recommended).

When the extractor is to be installed above a gas hob, the minimum distance between the hob and extractor must exceed 700mm (750mm is recommended).

If the instructions provided with your gas hob state that the required distance between the hob and extractor must be greater than 700mm, then that is the distance that should be observed; this is a legal requirement and may lead to your hob being disconnected from the gas supply and the installation being reported to RIDDOR (The height should be measured from the top of the burners).

IN THE ABSENCE OF ANY INSTRUCTIONS SUPPLIED WITH THE GAS HOB, THE MINIMUM DISTANCE BETWEEN THE HOB AND EXTRACTOR MUST BE AT LEAST 760mm.

The width of any hob must not be greater than the width of the extractor installed above it.

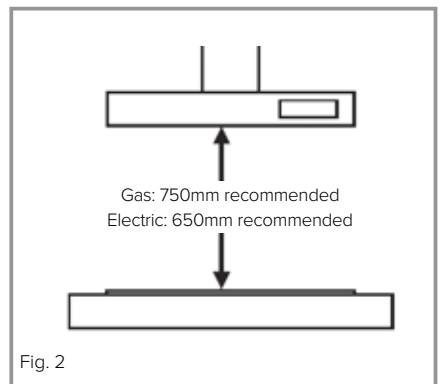

The metal casing of this appliance has been coated with a preservative to protect it during transport and storage. This should be removed during installation by using a non-abrasive stainless steel cleaner. Always follow the instructions given with the cleaner being used.

Installation - mounting

1. Mark the positions of the fixing holes on the wall using the dimensions shown in Fig. 3.
2. Drill and plug the wall with appropriate fixings, suitable for the wall type you are fixing the extractor on.
3. Mount the brackets and securely tighten.
4. Hang the hood on the brackets and adjust the brackets and height to suit. The adjustment mechanism is shown on page 14, Fig 4.
5. Once the hood is levelled and square against the wall, adjust the bottom panel as required (Fig. 5, page 14).
6. Secure the extractor to the adjacent units through the holes in the side of the product, to ensure that it cannot be accidentally knocked off the hanging brackets.

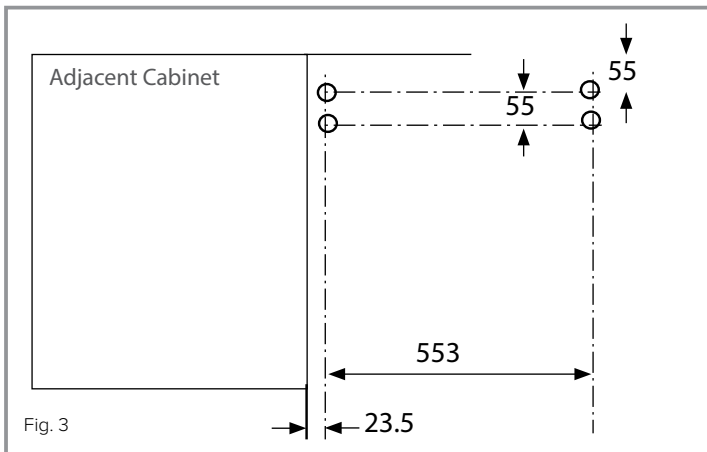

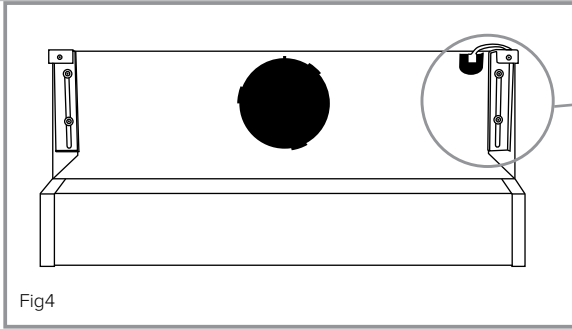

Fig4

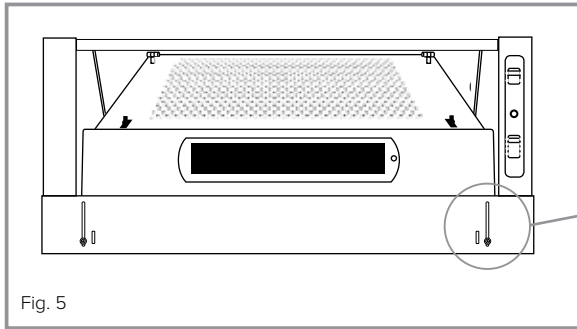
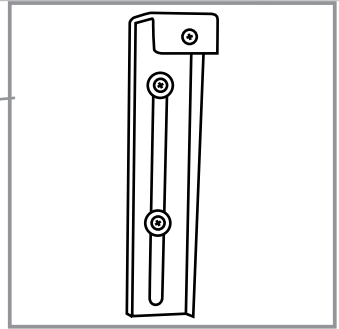
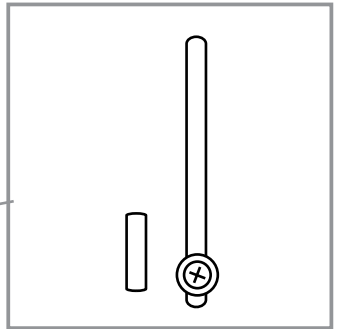

Fig. 5



Ducting

The ducting used should be rigid circular pipe and must be manufactured from fire retardant material, produced to BS 476 or DIN 4102-B1.

Wherever possible utilise rigid circular pipe which has a smooth interior, rather than the expanding concertina type ducting. The lengths of ducting with minimal effect on performance are as follows:

- 4 metres with 1 x 90° bend.
- 3 metres with 2 x 90° bends.
- 2 metres with 3 x 90° bends.

Longer ducting can be used but the performance of the extractor will likely be reduced. Noise may also be affected by the type of ducting.

Energy Efficiency Information

Attribute	Symbol	Value		Units
Model Identification		EIN60SI/2	EIN60FSI/2	
Annual Energy Consumption	AEC_{Hood}	26.6	26.6	kWh
Time increase factor	f	1.7	1.7	
Fluid Dynamic Efficiency	FDE_{Hood}	8.6	8.6	
Energy Efficiency Index	EEI_{Hood}	69.1	69.1	
Measured airflow at Best Efficiency Point	Q_{BEP}	99.2	99.2	m^3/h
Measured Pressure at Best Efficiency Point	P_{BEP}	120	120	Pa
Maximum airflow	Q_{MAX}	193.2	193.2	m^3/h
Measured electric power at Best Efficiency Point	W_{BEP}	38.2	38.2	W
Nominal lighting power	WL	4	4	W
Average illumination of the lighting system on the cooking surface	E_{Middle}	55	55	Lux
Measured power consumption in standby	P_S	NA	NA	W
Measured power consumption off mode	P_O	0	0	W
Sound power level	L_{WA}	62	62	dBA
Grease Filter Efficiency	GFE_{Hood}	70 (D)	46.2 (F)	%
Lamp efficiency	LE_{Hood}	14 (D)	14 (D)	%

E & O E. All instructions, dimensions and illustrations are provided for guidance only. CDA reserve the right to change specifications without prior notice.



C|D|A
Built for your life

For service or queries relating to your product please contact:

The Customer Care Department on **01949 862 012** or email customer.care@cda.eu

For more information please contact:

The Sales Department on **01949 862 010** or email sales@cda.eu

Customer Care Department. The CDA Group Ltd, Harby Road, Langar, Nottinghamshire, NG13 9HY
T: 01949 862 012 F: 01949 862 003 E: customer.care@cda.eu