

# HN6013FR

Plug and Play induction hob

Installation, use and maintenance

---

# Contents:

- 3 Important information
- 4 Important safety warnings/notes
- 4 Important notes for safety, use and care
- 6 Pacemaker and active implants information
- 7 Cooking on induction
- 8 Important safety warnings
- 8 Saving energy
- 9 Using your hob(s)
- 9 Hob layout
- 14 Selecting suitable cookware (pan compatibility)
- 18 Child lock
- 19 Residual heat indicators
- 20 Booster function
- 22 Maximum operating time
- 22 Timer
- 24 Minute minder
- 24 Stop'n go function
- 25 Maintain temperature
- 28 Fitting the hob (ventilation, furniture requirements etc.)
- 29 Installation
- 32 Electrical information
- 34 Troubleshooting
- 38 Care and maintenance
- 39 Cleaning advice

## Important

The CDA Group Ltd cannot be held responsible for injuries or losses caused by incorrect use or installation of this product. Please note that CDA reserve the right to invalidate the guarantee supplied with this product following incorrect installation or misuse of the appliance or use in a commercial environment.

This appliance is not designed to be used by people (including children) with reduced physical, sensorial or mental capacity, or who lack experience or knowledge about it, unless they have had supervision or instructions on how to use the appliance by someone who is responsible for their safety.

Under no circumstances should any external covers be removed for servicing or maintenance except by suitably qualified personnel.

### **Appliance information:**

Please enter the details on the appliance rating plate below for reference, to assist CDA Customer Care in the event of a fault with your appliance and to register your appliance for guarantee purposes.

Appliance Model	
Serial Number	

### **EU Declarations of Conformity**

This appliance has been designed and manufactured to comply with all applicable UK and EU legislation, Low voltage Directive, 2014/35/EU

Electromagnetic compatibility Directive, 2014/30/EU

ErP Directive, 2009/125/EC

RoHS Directive, 2011/65/EU

and has been marked with the following symbols



**IMPORTANT INFORMATION FOR CORRECT DISPOSAL OF THE PRODUCT IN ACCORDANCE WITH EC DIRECTIVE 2012/19/EU.**

At the end of its working life, the product must be taken to a special local authority waste collection centre or to a dealer providing appliance recycling services.

Disposing of a household appliance separately avoids possible negative consequences for the environment and health. It also enables the constituent materials to be recovered, saving both energy and resources. As a reminder of the need to dispose of household appliances separately, the product is marked with a crossed-out wheeled dustbin. 

**Warning:** The appliance and its accessible parts become hot during use. Care should be taken to avoid touching heating elements. Children less than 8 years of age shall be kept away unless continuously supervised. This appliance can be used by children aged from 8 years and above and persons with reduced physical, sensory or mental capabilities or lack of experience and knowledge if they have been given supervision or instruction concerning use of the appliance in a safe way and understand the hazards involved. Children shall not play with the appliance. Cleaning and user maintenance shall not be made by children without supervision.

**Warning:** Unattended cooking on a hob with fat or oil can be dangerous and may result in fire. NEVER try to extinguish a fire with water, but switch off the appliance and then cover flame e.g. with a lid or a fire blanket.

**Warning:** Danger of fire: do not store items on the cooking surfaces.

**Warning:** If the surface is cracked, switch off the appliance to avoid the possibility of electric shock. Metallic objects, such as knives, forks, spoons and lids should not be placed on the hob surface since they can get hot. After use, switch off the hob element by its control and do not rely on the pan detector. The appliance is not intended to be operated by means of an external timer or separate remote-control system. You should not use steam cleaning devices to clean the appliance.

**Please note:**

- Induction hobs become hot and remain hot during and immediately after use. Do not touch the hob until it has been allowed to cool.
- Keep children away from the appliance when in use.
- Never use the hob top for storage.
- Pan handles should never stand out beyond the edge of the worktop. This will help to avoid children reaching them.
- Do not lean over the hob when it is in use.
- Follow the cleaning instructions carefully.
- Ensure the base of the saucepan is clean and dry before placing it on the hob.

- Avoid hard shocks from cookware, dropping pepper mills etc. – the vitroc ceramic glass surface is highly resistant but not unbreakable.
- Do not place hot lids flat on the hob top. A “suction” effect could cause damage to the hob.
- Do not drag cookware across the hob top: in the long term, this could cause damage to the hob.
- Do not store cleaning or flammable products in the unit below the hob.
- Always use appropriate cookware.
- Do not cook unopened tins of food directly on the hob.
- Never put cooking foil or plastic materials on the ceramic surface when the hob is hot. These materials could melt and cause damage to the hob.
- This hob (Class 3) has been designed for use only as a cooking appliance in a domestic environment. Any other use should be considered incorrect and therefore dangerous.

**FOR THOSE WITH HEART PACEMAKERS OR ACTIVE IMPLANTS:**

The function of this hob conforms to current electromagnetic interference standards and thus is in total compliance with legal requirements (2004/108/CE directives).

To avoid interference between your hob and a pacemaker, your pacemaker must be designed and programmed in compliance with the regulations that apply to it. As such, CDA guarantee only that our product is compliant.

With regard to the compliance of the pacemaker or any potential incompatibility, you should obtain information from the manufacturer or your attending physician.

## Cooking on Induction

The principle of induction cooking is based on magnetic effect. When you put your cookware on an induction zone and switch it on, the electronic boards in the hob produce induced currents in the base of the cookware and instantly raise its temperature. This heat is then transferred to the food inside the cookware.

The best cookware to use with induction cooking has thick flat bases, as the heat will be better distributed meaning cooking is more even. Most cookware is compatible with induction cooking.

### **There are three ways to check the suitability of your cookware:**

1. Using a magnet to see if the base of the pan is magnetic: If the magnet sticks, then the cookware is compatible.
2. Place the pan on one of the cooking zones and switch the zone on. If the display continues to show the selected power level then the cookware is compatible. If the display shows “E”, the cookware cannot be used on an induction hob.
3. Check the instructions or packaging of the pans for the symbols indicating suitability for use with induction.

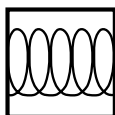

---

## Important

- Do not use the hob if the glass surface is cracked or damaged to prevent the risk of electric shock. Disconnect it from the power supply.
- Ensure that the power cable of a connected electrical appliance near the hob is not in contact with the cooking zones.

## Saving energy

Using energy in a responsible way not only saves money but also helps the environment. The following will help you to save energy:

- Use proper pans for cooking. A saucepan should never be smaller than the zone. Always remember to cover any pans.
- Ensure pans and the hob are kept clean. Soils can prevent heat transfer and repeatedly burnt-on spillages can often only be removed by products which cause damage to the environment.
- Do not uncover the pan too often (a watched pot never boils!).

**Be sure to recycle all of the packaging.**

**All packaging materials used are 100% recyclable.**



# Using your hob

## Zones:

1. Front left  
Power Booster induction cooking zone
2. Back left  
Booster induction cooking zone
3. Back right  
Booster induction cooking zone
4. Front right  
Booster induction cooking zone

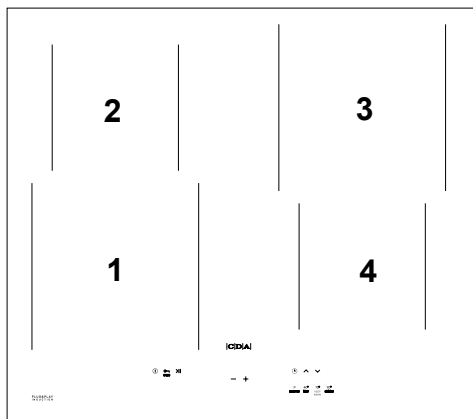

## Control Panel

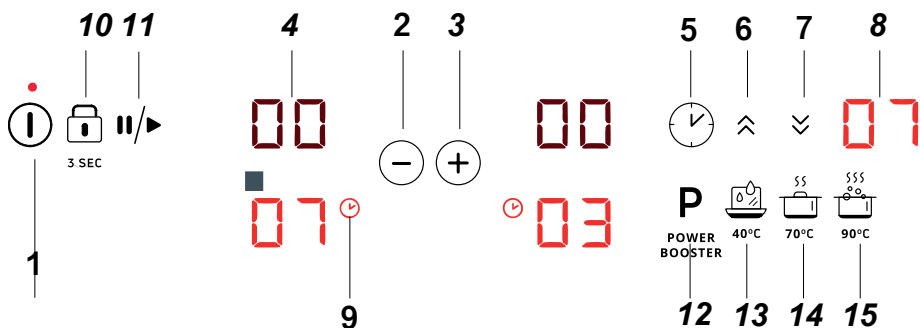

1. Sensor on/off board with LED
2. Minus power setting sensor
3. Plus power setpoint sensor
4. Cooking zone indicator
5. Clock sensor
6. Clock sensor +
7. Clock sensor -
8. Clock indicator
9. Sensor key
10. Sensor pause
11. Sensor power amplifier
12. Temperature maintenance program 40<sup>o</sup>
13. Temperature maintenance program 70<sup>o</sup>
14. Temperature maintenance program 90<sup>o</sup>

# Operation

Before using the appliance for the first time

- Thoroughly clean your induction hob first. The induction hob should be treated with the same care as a glass surface.
- Switch on the ventilation in the room or open a window, as the appliance could emit an unpleasant smell during first use.
- Operate the appliance while observing all safety guidelines.

## **Induction cooking zone operation principle**

An electric oscillator powers a coil placed inside the appliance. This coil produces magnetic fields which induce eddy currents in the cookware. The eddy currents induced by the magnetic field cause the cookware to heat up.

This requires the use of pots and pans whose base is ferromagnetic, in other words susceptible to magnetic fields.

Overall, induction technology is characterized by two advantages:

- Heat is only emitted by the cookware and energy use is optimised.
- There is no thermal inertia, since the cooking starts immediately when the pot is placed on the hob and ends once it is removed. This means the hob responds instantly to changes in power.

Certain sounds can be heard during normal use of the induction hob, which do not affect its correct operation.

- Low-frequency humming. This noise arises when the cookware is empty and stops when water is poured or food is placed in the cookware.

- High-frequency whizz. This noise arises in cookware made of multiple layers of different materials at maximum heat setting. The noise intensifies when using two or more cooking zones at maximum heat setting. The noise will stop or reduce when heat setting is reduced.
- Creaking noise. This noise arises in cookware made of multiple layers of different materials. The noise intensity depends on how the food is cooked.
- Buzzing. Buzzing can be heard when electronics cooling fan operates.

The noises that can be heard during the normal appliance operation are the result of the cooling fan operation, cooking method, cookware dimensions, cookware material and the heat setting. These noises are normal and do not indicate a fault.

## Demo Mode

This function allows you to activate the demonstration mode.



Demo mode activation of your induction hob can be set within 5 minutes of connecting the induction hob to the mains. To select a power setting, touch ⓘ to turn on the appliance and then touch and hold ⏸/▶ and ⏵ simultaneously for 3 seconds.

The twin display will show the previous setting or — if there was no previous setting — the default setting of 2.8kW shown as “28”. Use ⏶ and ⏷ to select the desired setting. Within 10 seconds of selecting the desired setting, touch and hold ⏵ for 3 seconds to confirm.

00	DEMO
28	2.8kW



You will hear a beep and the selected maximum power setting will flash several times on the display and then the appliance will turn off. Now your operating induction hob will not exceed the total maximum power you selected.



If you do not confirm the selected maximum power setting, your induction hob will turn off and operate with the previously selected maximum power or with the default power of 2.8kW.

When you select heat setting on individual cooking zones, the Power Management circuit will ensure that the selected total maximum power is not exceeded. Any setting that would cause the total maximum power to be exceeded will be unavailable to the user. The Power Management circuit may disable a cooking zone if using it would cause the total maximum power of the appliance to be exceeded.

### **Hob Protection**

If the hob has been installed correctly and is used properly, any protective devices are rarely required.

**Fan:** Protects and cools controls and power components. It can operate at two different speeds and is activated automatically. Fan runs until the electronic system has sufficiently cooled down regardless of the appliance or the cooking zones being turned on or off.

**Temperature sensor:** Temperature of electronic circuits is continuously monitored by a temperature sensor. If temperature is raised beyond a safe level, this protection system will reduce cooking zone heat setting or shut down the cooking zones adjacent to the overheated electronic circuits.

**Pan detection:** allows the hob to detect pans placed on a cooking zone. Small objects placed on the cooking zone (eg, spoon, knife, ring ...) will not be recognised as pans and the hob will not operate.

## **Pan detector**

Pan detector is installed in induction hobs. Pan detector starts heating automatically when a pan is detected on a cooking zone and stops heating when it is removed. This helps save electricity.

- When an suitable pan is placed on a cooking zone, the display shows the heat setting.
- Induction requires the use of suitable cookware with ferromagnetic base (see Table).

If a pan is not placed on a cooking zone or the pan is unsuitable, the symbol is displayed. The cooking zone will not operate. If a pan is not detected within 10 minutes, the cooking zone will be switched off. Switch off the cooking zone using the touch control sensor field rather than by removing the pan.



Pan detector does not operate as the on/off sensor.

The induction hob is equipped with electronic touch control sensor fields, which are operated by touching the marked area with a finger. Each time a sensor field is touched, an acoustic signal can be heard.

When switching the appliance on or off or changing the heat setting, attention should be paid that only one sensor field at a time is touched. When two or more sensor fields are touched at the same time (except timer and child lock), the appliance ignores the control signals and may trigger a fault indication if sensor fields are touched for a long time.

When you finish cooking switch off the cooking zone using touch control sensor fields and do not rely solely on the pan detector.

### Selecting cookware for induction cooking

High-quality cookware is an essential condition for efficient induction cooking.

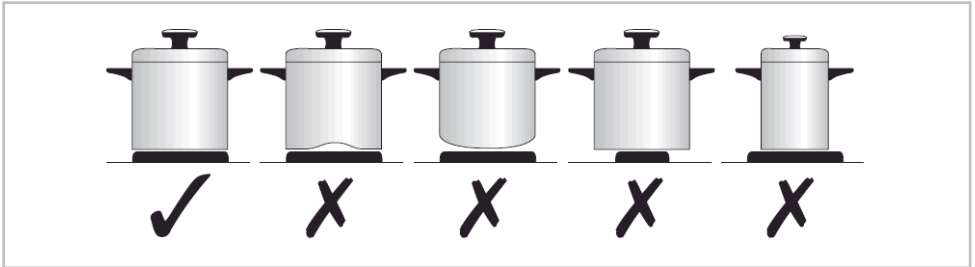

### Cookware characteristics

- Always use high quality cookware, with perfectly flat base. This prevents the formation of local hot spots, where food might stick. Pots and pans with thick steel walls provide superior heat distribution.
- Make sure that cookware base is dry: when filling a pot or when using a pot taken out of the refrigerator make sure its base is completely dry before placing it on the cooking zone. This is to avoid soiling the surface of the hob.
- Lid prevents heat from escaping and thus reduces heating time and lowers energy consumption.
- To determine if cookware is suitable, make sure that its base attracts a magnet.
- **Cookware base has to be flat for optimal temperature control by the induction module.**
- **The concave base or deep embossed logo of the manufacturer**

interfere with the temperature induction control module and can cause overheating of the pot or pan.

- **Do not use damaged cookware such as cookware with deformed base due to excessive heat.**
  - When you use large ferromagnetic base cookware, whose diameter is less than the total diameter of the cookware, only the ferromagnetic base heats up. This results in a situation where it is not possible to uniformly distribute the heat in the cookware. If the ferromagnetic area is reduced due to inclusion of aluminium parts then the effective heated area can be reduced. Problems with the detection of the cookware could arise or cookware may not be detected at all. To achieve optimum cooking results, the diameter of the ferromagnetic base should match that of the cooking zone.
- If cookware is not detected in a given cooking zone, it is advisable to try it in a smaller cooking zone.

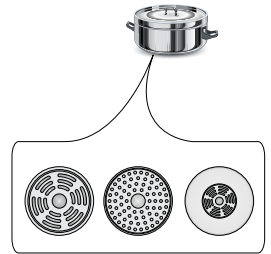

For induction cooking us only ferromagnetic base materials such as:

- Enamelled steel.
- Cast iron.
- Special stainless steel cookware designed for induction cooking.

<b>Marking of kitchen cookware</b>	Check for marking indicating that the cookware is suitable for induction cooking.
	Use magnetic cookware (enamelled steel, ferrite stainless steel, cast iron). The easiest way to determine if your cookware is suitable is to perform the “magnet test”. Find a generic magnet and check if it sticks to the base of the cookware.
<b>Stainless steel</b>	Cookware is not detected.
	With the exception of the ferrimagnetic steel cookware.
<b>Aluminium</b>	Cookware is not detected.
<b>Cast iron</b>	High efficiency.
	Caution: cookware can scratch the hob surface.
<b>Enamelled steel</b>	High efficiency.
	Cookware with a flat, thick and smooth base is recommended.
<b>Glass</b>	Cookware is not detected.
<b>Porcelain</b>	Cookware is not detected.
<b>Cookware with copper base</b>	Cookware is not detected.

The smallest useful diameter of cookware for a cooking zone:

Cooking zone diameter	The minimum diameter of the bottom of an enamelled steel cookware
[mm]	[mm]
160 - 180	110
180 - 200	
210 - 220	125
220 x 190	
260 - 280	

The minimum diameter of cookware made of materials other than enamelled steel may vary.



## Control panel

- Immediately after the appliance is connected to electrical mains, all displays will light up briefly. Your appliance is then ready for use.
- The induction hob is equipped with electronic touch control sensors, which are operated by touching with a finger for at least 1 second.
- Touching of a sensor is accompanied by a beep to acknowledge.



Do not place any objects on the sensors of the control panel. Make sure that cookware is not placed beyond the outline of the cooking zone. If you place cookware too close to the control panel or you cover any sensors, the hob will automatically turn off for safety.

## Turn on the appliance

Touch and hold the on/off  sensor for at least 3 seconds. The Hob indicates correct operation (active) when “00” is shown on the cooking zone displays.



If you do not set the desired heat setting of the cooking zone within 15 seconds of activating the appliance, it will turn off automatically.

## Activate cooking zone and set the heat setting

- Turn on the hob with the  sensor.
- Place the cookware on the desired cooking zone.
- The cookware will be automatically detected and the relevant display will show flashing “00.” This means that the selected cooking zone is active and you can set the power.



If there are two or more pans on the hob when it is turned on, the hob will not activate the cooking zones automatically. You need to touch the sensor corresponding to your desired cooking zone.

- Use the heat setting touch sensors  $\oplus$  and  $\ominus$  to set the heat setting and it will be indicated on the display.
- The cooking zone operates.





The cookware detection and automatic cooking zone activation only works for the first pan placed on the hob.



The Booster function can be used for one field. It is not possible to activate two or more Boosters at the same time. Activation of the Booster function is not possible if the other pole is set too high the vertical power is already enabled for the Booster function.

## Child lock

The Child Lock function disables all hob controls for cleaning or to prevent children from using the appliance. The Child Lock function can be set when the appliance is turned on or off. To enable or disable the Child Lock function, hold the  sensor for 3 seconds. When the lock is on, an indicator light next to the  sensor is on.



When the hob is turned on and locked, you can turned it off immediately by touching the  sensor.



Disconnecting the appliance from electrical mains deactivates the Child Lock.

### **Residual heat indicator “h”, “H”**

When you have finished cooking, the induction hob glass within the cooking zone is still hot, this is called residual heat.

If the glass temperature is higher than 60°C\*, display of the cooking zone shows “H”.



If the glass temperature is 45°C\* – 60°C \*), the cooking zone display shows “h” (low residual heat).



*\* Temperatures are approximate*



When residual heat indicator is on, do not touch the cooking zone as there is a risk of burns and do not place on it any items sensitive to heat!



The “H” or “h” residual heat indicator is not displayed during a power outage. However, cooking zones may still be hot!

## Deactivate cooking zones

Deactivate cooking zone by doing one of the following:

- Turn off the hob with the ⓘ sensor.
- Touch and hold the **BB** sensor for 3 seconds.
- Activate the cooking zone - simultaneously touch and hold the heat setting touch sensors ⊕ and ⊖ .
- Activate the cooking zone and use the heat setting touch ⊖ sensor to set the heat setting to “0”.

## Turn off the appliance

The appliance operates when at least one cooking zone is on.

- Turn off the hob with the ⓘ sensor.



If a cooking zone is still hot, the relevant display will show the letter “H” or “h” to indicate residual heat. For description of the symbol, see below.

## Booster function “P”

The Booster Function increases the nominal power of the Ø 210 mm cooking zone from 2000W to 2800W, and the Ø 160 mm cooking zone from 1400W to 2100W.

- Place the cookware on the desired cooking zone.
- The cookware will be automatically detected and the relevant display will show flashing “00.”
- Touch the “P” sensor to activate the Booster function. The display will show the letter “P.”

Turn off the Booster function:

- Touch the Booster sensor or touch ⊖ to reduce the heat setting.



Booster function can be activated for up to 5 minutes.

Then power will be reduced to 14 (nominal power).

Power will also be reduced to the nominal power, if any hob components overheat.

You can reactivate the Booster function when the internal components cool down to a safe temperature. This function will not start automatically.

When you take the cookware off the cooking zone when the Booster function is on, a 5-minute countdown will not be interrupted.

## Maximum operating times

In order to ensure the safety of users, the induction hob is fitted with an operating time limiter for each of the cooking zones.

The maximum operating time is determined individually depending on the heat setting when cooking. If you only use one heat setting for an extended period of time, the maximum cooking time is given in the table:

After reaching the maximum cooking time, the induction zone deactivates automatically, and the display shows residual heat symbol. The maximum working time applies to a single cooking zone.



Cooking heat setting	Maximum operating time
1	8h
2	8h
3	8h
4	8h
5	5h
6	5h
7	5h
8	5h
9	1.5h
10	1.5h
11	1.5h
12	1.5h
13	1.5h
14	1.5h
P	5min
40	60min
70	160min
90	160min
☰	60min

## Timer

The timer function makes cooking easier by making it possible to set Duration. You can activate the Timer function only when cooking (when heat setting is greater than “0”). You can use the Timer function on all cooking zones at the same time. Maximum time is 99 minutes (1 minute step).

To set the timer:

- Place the cookware on the desired cooking zone.
- When cookware is auto detected, set the heat setting.
- To activate the Timer, touch and hold  until you hear a beep. The display will show “00”.

- Touch  to add time and  to reduce time.

To set the Time for the next cooking zone, follow the above steps by selecting a different cooking zone. Keep in mind that the Timer function can be set for each cooking zone.









If more than one timer is set, the shortest duration is displayed.



Timer Duration setting can be changed at any time. During cooking, select the cooking zone for which you wish to change timer duration setting, i.e. activate it with the **BB** sensor, touch  and change the duration setting as per Timer setting instructions.

When the set cooking time has elapsed, you will hear an alarm beep. Touch any sensor to mute it or the alarm will turn off automatically after 30 seconds.

If you want to cancel the timer ahead of time, activate the desired cooking zone by touching its sensor (the power indicator will flash), then cancel the timer as follows:

- touch and hold the  sensor;
- touch  to reduce the time to “00”;
- simultaneously touch and hold  and .



To cancel the Timer, touch **BB** (heat setting indicator will flash), then touch and hold  for 3 seconds or touch  to activate the desired cooking zone, then touch and use  to reduce the time to “00.”





To cancel the Timer you can also simultaneously touch and hold  and  for 2 seconds.

## Minute minder





Use Minute Minder to count down time. The Minute Minder does not affect the operation of cooking zones.

To set the Minute Minder:

- Turn on the hob.
- Touch  and set the Minute Minder duration by touching  to add duration and  to reduce duration.



 The Duration setting can be changed at any time. To do this, touch  and then use  or .

When the set Duration has elapsed, you will hear an alarm beep. Touch any sensor to acknowledge and mute it. The alarm goes off automatically after 30 seconds.

 To cancel the Minute Minder touch , then touch and hold  to reduce the duration to “00.” or, alternatively, simultaneously touch and hold  and .

## The Stop’n go function

The Stop’n go function simultaneously suspends operation of all cooking zones and then resumes at the heat settings that were previously set. In order to activate the Stop’n go function, at least one cooking zone must be in use.

Touch the  sensor. All cooking zone displays will show the  symbol. When a cooking zone is hot the symbol will flash alternately with the



letter “H” or “h”, depending on cooking zone temperature (residual heat indicator).

To deactivate the Stop’n go function touch the  sensor again.

Cooking zone displays will show the heat setting that was previously set before activation of the Stop’n go function.

- The Stop’n go function pauses the Timer countdown
- The Stop’n go function does not pause the Minute Minder countdown

## **Maintain temperature**

Your hob is equipped with special programmes that allow you to cook at the set temperature while consuming the least possible amount of energy.

Four programmes are available ( \* subject to model ):

- Melt 40

This is intended for melting butter or a bar of chocolate.

Place the butter or chocolate in a pan at room temperature and then activate the Melt 40 programme.

- Keep Warm 70

A programme ideal for heating thick soups or sauces.

Place the pot with the food on the cooking zone and activate the Keep warm 70 programme. This programme maintains a temperature of 70°C.

---

•Simmer 90

A programme intended for heating and cooking watery dishes. Place the pot with the food on the cooking zone and activate the programme. This programme maintains a temperature of 90°C.

Sear 200

A programme intended for searing dishes that require high temperature. Place a pan or a dedicated grill tray on the cooking zone and activate the Sear programme. The programme maintains a temperature of 200°C.

Activate the maintain temperature programme.

- Place the cookware on the cooking zone.
- Activate the cooking zone.
- Activate the selected temperature programme.

# Practical Everyday Tips

Table of example hob settings.

Function	Use	Dish	Time [min]	Portion size
Melt 40*	Melt chocolate	Brownie / chocolate fondant	10	300g
Melt 40*	Defrost	Meat	60	1 piece approx. 800g
Melt 40*	Proof yeast dough	Yeast dough	40	1kg
Keep Warm 70*	Parboil meats and sausages	Pork loin with spices	60	1kg
Keep Warm 70*	Sous vide	Sous-vide chicken fillet	60	1 piece 200g
Keep Warm 70*	Maintain temperature	Soup	30	2l
Keep Warm 70*	Keep warm	Hot chocolate	10	0.5l
Simmer 90*	Healthy breakfast	Oatmeal	20	0.5l
Simmer 90*	Soup	Chicken broth	150	4l
Simmer 90*	Cooking	Poached eggs	12	2 pieces egg
Sear**	Grilling	Grilled steak	6	1 piece 300g
Sear**	Stir-fry	Chicken with vegetable noodles	8	1 portion approx. 400g
Sear**	Deep fry	Vegetables in tempura	6	300g

\*symbol depends on the model

\*\* in selected models

# Fitting the hob

## Unpacking the hob:

Take care not to lose, drop or mishandle any parts.

## Fitting position of the hob:

This appliance must be, **when installed**, a minimum of 50mm from any back wall and a minimum of 180mm away from any adjacent vertical surfaces, e.g. a tall cupboard end panel. This may be reduced to 100mm if the adjacent surface is resistant to fire (tiles or steel for example). These dimensions are shown in Fig.8 below.

If a splashback/worktop upstand is to be fitted, take this into account when cutting the hole. The minimum distance that the hob should be positioned away from the rear wall or splashback, when installed, is 50mm.

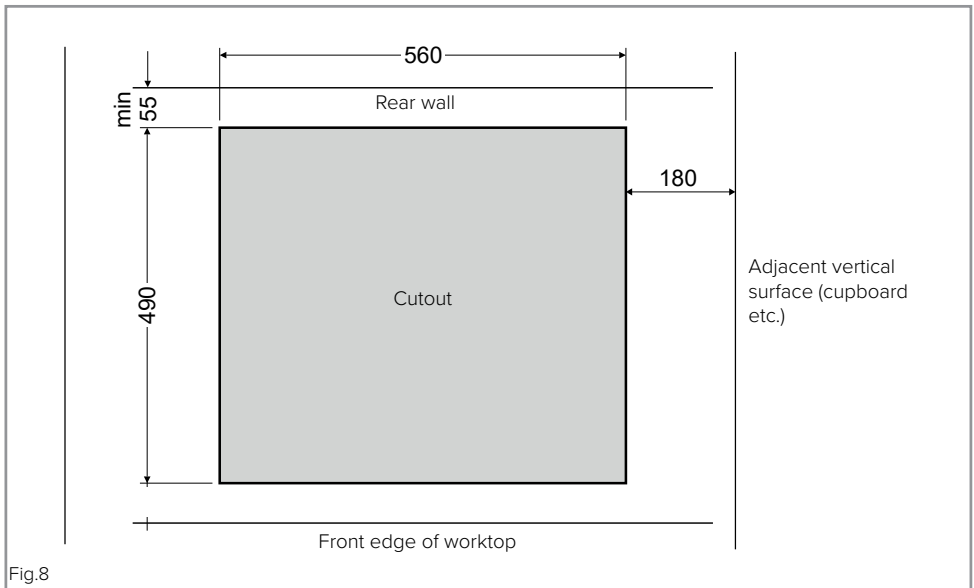
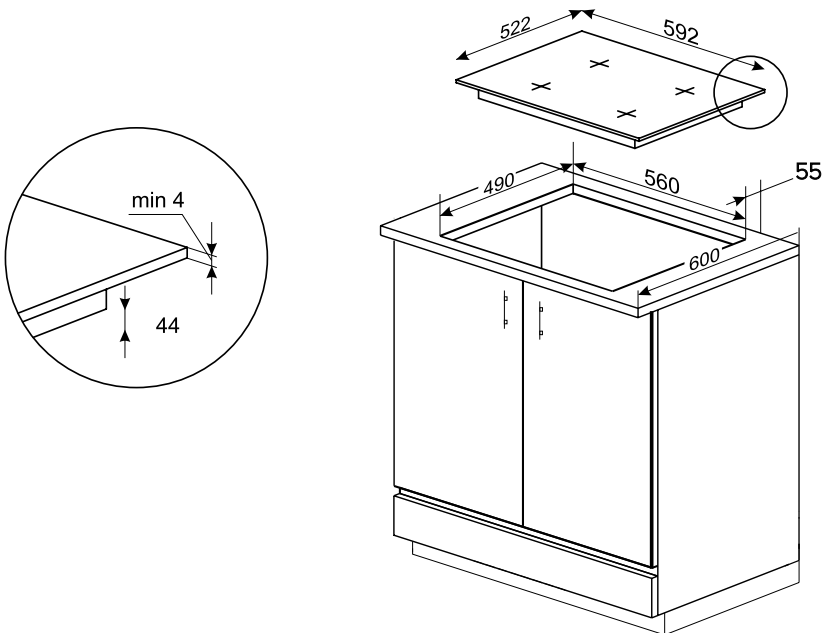

Fig.8

# Installation

## Making the worktop aperture

- The worktop must be flat and level. Edge of the worktop near the wall must be sealed to prevent ingress of water or other liquids.
- There should be sufficient spacing around the opening, in particular, at least 50 mm distance to the wall.
- The distance between the edge of the opening and the side wall of the furniture should be minimum 55 mm.
- Worktop must be made of materials, including veneer and adhesives, resistant to a temperature of 100°C. Otherwise, veneer could come off or surface of the worktop become deformed.
- Edge of the opening should be sealed with suitable materials to prevent ingress of water.
- Worktop opening must cut to below dimensions.
- Ensure minimum clearance of 25 mm below the hob to allow proper air circulation and prevent overheating.



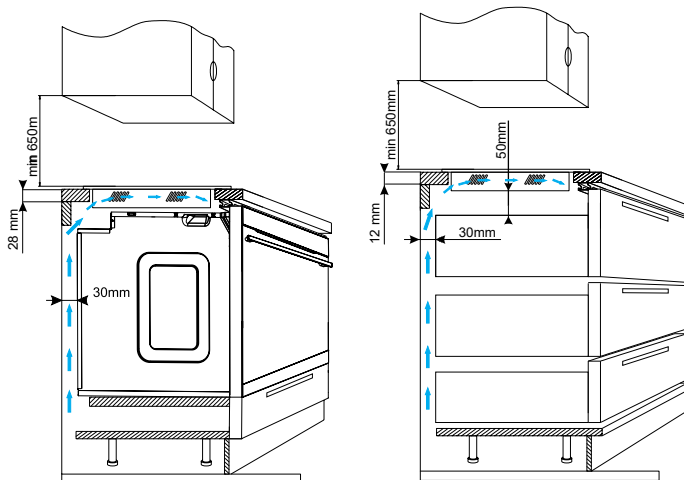

Do not install the hob above an oven without ventilation.

### **If fitting a cooker hood above the hob:**

If a cooker hood is to be installed above the hob, the height of the hood above the hob must be at least 600mm (650mm is recommended) (Fig.6).

If the instructions supplied with the hood dictate that the hood must be installed at a height greater than 600mm, then that height is the minimum required.

### **Wall furniture requirements:**

The minimum height of any cabinet immediately above the hob is 900mm. The minimum height of any adjacent units (including light pelmets) is 400mm, unless they are manufactured from a material resistant to fire (steel, for example).

## Assembly of the gasket

If the seal has not been fitted at the factory, proceed as follows: Before installing the hob in the cut-out worktop, the gasket is to be attached to the back of the hob. To do this, first peel off the protective film from the self-adhesive seal and glue the gasket as close as possible to the outer edge of the hob (fig 4).

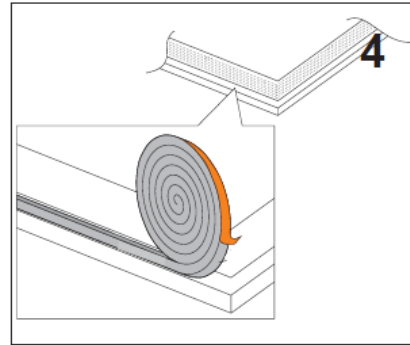

### Important Notes!

- Do not position this appliance above a refrigeration unit. The heat generated may cause the refrigeration unit to fail.
- Do not position this appliance above a dishwasher or similar unit. The moisture generated may cause serious issues.
- This appliance is designed to be installed into and around cabinet units and in worktop capable of withstanding temperatures of 100°C+.
- Never place perishable foods, cleaning products or flammable items in the cupboard below the appliance.
- If an oven is to be installed below the hob, the thermal safety system on the hob may not allow the hob to be used at the same time as a pyrolytic programme on the oven.
- If the hob is to be located above a working drawer, we recommend that the drawer is not used for storing soft items, for example dusters or towels; this is to minimize the risk of the cooling system air intakes being obstructed.

# Electrical Information

**Warning! This appliance must be earthed.**

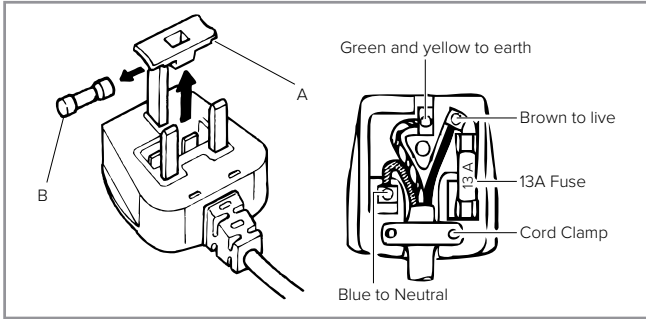

The mains lead of this appliance has been fitted with a BS 1363A 13 amp fused plug. To change a fuse in this type of plug, follow the steps below:

1. Remove the fuse cover and fuse.
2. Fit replacement 13A fuse, ASTA approved to BS 1362 type, into the fuse cover.
3. Replace fuse cover.

**Important: Do not use the appliance without the fuse cover in position.**

## **How to connect an alternative plug**

If the fitted plug is not suitable for your socket outlet, then it should be cut off and disposed of safely to avoid the risk of electric shock. A suitable alternative plug of at least 13Amp rating to BS 1363 should be used.



As the colours of the wires in the mains lead of this appliance may not correspond with the coloured markings identifying the terminals in your plug, proceed as follows:-

- The wire which is coloured GREEN and YELLOW must be connected to the terminal which is marked with the letter (E) or by the Earth symbol  $\perp$  or coloured GREEN and YELLOW.
- The wire which is coloured BLUE must be connected to the terminal which is marked with the letter (N) or coloured BLACK or BLUE.
- The wire which is coloured BROWN must be connected to the terminal which is marked with the letter (L) or coloured RED or BROWN.

If in doubt regarding the electrical connection of this appliance, consult a qualified electrician.

Do not shorten the supply cable, the appliance may require removing for servicing.

**N.B. Ensure that the plug socket is situated in an easily accessible place.**

# Troubleshooting

In the event of any fault:

- Turn off the appliance
- Disconnect the power supply
- Have the appliance repaired
- Based on the instructions given in the table below, some minor issues can be corrected by the user. Please check the consecutive points in the table before you refer the repair to customer service.

<b>Problem</b>	<b>Possible Cause</b>	<b>Remedy</b>
The "L" symbol is shown on the display when you try to turn on the appliance.	The Child Lock is enabled.	Touch and hold the Child Lock sensor for 3 seconds to disable the Child Lock.
The appliance does not turn on when you press the on/off sensor.	You do not hold down the on/off sensor long enough	Hold down the on/off sensor for 3 seconds.
	Soiled / wet control panel sensors	Wipe the control panel clean and remove any objects that obscure the sensors.
	Power outage	Check the MCB or fuses in your home electrical distribution box.
	External power interference.	Unplug the appliance from the power outlet for 120 seconds or disconnect the miniature circuit breaker (MCB) or fuse in your home electrical distribution box.
During operation, the appliance emits a long beep and turns off.	The safety feature has operated.	Wipe the control panel clean and remove any objects that obscure the sensors.

<b>Problem</b>	<b>Possible Cause</b>	<b>Remedy</b>
After turning on, the appliance turns itself off.	You have not used any appliance function.	When turn on the appliance, use it without delay.
The cooking zone has turned itself off.	The maximum operating time has been reached.	Activate the cooking zone again and set the heat setting.
Noises are heard during cooking.	Normal operation of the appliance. The noises emitted depend on the pots used and the heat setting.	
The “h” or “H” symbol is shown on the cooking zone display.	Normal operation of the appliance. The “h” or “H” symbols indicate that the cooking zone is warm/hot and extra care is required.	
F0 is shown on the cooking zone display.	Supplied voltage too low.	Contact your electricity supplier.
F1 is shown on the cooking zone display.	Supplied voltage too high.	Contact your electricity supplier.
F2 is shown on the cooking zone display.	Electronic protection has been activated.	Check that the cooling fan opening is not obstructed.
F3 is shown on the cooking zone display.	The cooking zone protection has been activated.	Remove the cookware from the cooking zone and wait until the F3 symbol goes off.
F4 , F5, F6, F7, F8 or F9 is displayed on the cooking zone display.	External power interference.	Unplug the appliance from the power outlet for 120 seconds or disconnect the miniature circuit breaker (MCB) or fuse in your home electrical distribution box.
Cracked ceramic plate	Danger! Immediately unplug the appliance from the power supply or disconnect the miniature circuit breaker (MCB) or fuse in your home electrical distribution box. Refer the repair to the nearest service centre.	

# Troubleshooting

## If your hob does not appear to be working well:

Check with your installer, if you are at all unsure, as to what power level the hob is configured to. Any power setting lower than 7.4kW will implement the power management feature whereby the hob limits zones used and/or powers zones in bursts to try and ensure even performance between all active zones. This means that 4 zones on full power on a 6.0kW power setting will not perform the same as said zones on full power at 7.4kW.

**IMPORTANT: Never reconfigure your hob's power setting without your installer or electrician present to confirm the fuse and cable protecting the appliance and subsequently if it is safe to do so.**

## Specification

Rated voltage:	220-240V~50 Hz 1N
Rated power:	2.8kW
Type:	PBP4VI540L2FTB4AUUt HN6013FR
Induction cooking zone power:	
- induction cooking zone: Ø 210-220 mm	2000W
- induction cooking zone: Ø 160-180 mm	1400W
- booster induction cooking zone: Ø 210-220 mm	2800W
- booster induction cooking zone: Ø 160-180 mm	2100W
Dimensions (mm):	592 x 522 x 48
Weight (kg):	Approx. 7.85

Meets the requirements of European standards BSEN 60335-1; BSEN 60335-2-6.



Product information given in accordance with Commission Regulation (EU) No 66/2014 supplementing Directive of the European Parliament and Council Directive 2009/125/EC with regard to eco-design requirements for household ovens, hobs and range hoods.

## Household electric hobs

Model identifier	HN6013FR	
	PBP4VI540L2FTB4AUUt	
	21694	
Hob type (electric / gas / gas-electric)	V / O / O	
Number of cooking zones	4	
Heating technique (induction cooking zones or heating areas, radiant heating zones, solid hobs)	V / O / O	
Usable surface diameter for electric cooking zone rounded to 5mm (Ø cm) / Length and width of useful surface area per electric heatd cooking zone or area, rounded to the nearest 5mm [L x W (cm)]	FL	Ø 21,0
	RL	Ø 16,0
	RR	Ø 21,0
	FR	Ø16,0
Energy consumption for each cooking zone per kg, EC electric cooking [Wh/kg]	FL	174,9
	RL	174,9
	RR	174,9
	FR	174,9
Energy consumption by the hob per kg, EC electric hob [Wh/kg]	174,9	

**In order to determine compliance with the eco-design requirements, the measurement methods and calculations of the following standards were applied:**

EN 60350-1

EN 60350-2

## Care and maintenance

Always disconnect the appliance from the power supply before undertaking any cleaning or maintenance.

### **Important:**

- Steam cleaners must not be used when cleaning this appliance.
- You should use a non-abrasive cleaner to clean the hob top. Any abrasive cleaner (including Cif) will scratch the surface and could erase the control panel markings.
- Sugar and starch can cause permanent damage to the surface of the hob. Wipe away any spillages immediately but be careful given that the hob top will be hot during and after usage.
- Avoid letting pans boil over where possible to ensure that the need for cleaning is minimal.
- Always use a soft sponge or cloth where possible. Utensils such as scouring sponges and some brushes could cause scratches to the hob top.

### **Contacting CDA Customer Care**

A: Customer Care Department, The CDA Group Ltd, Harby Road,  
Langar, Nottinghamshire, NG13 9HY

T: 01949 862 012

F: 01949 862 003

E: [customer.care@cda.co.uk](mailto:customer.care@cda.co.uk)

W: [www.cda.co.uk](http://www.cda.co.uk)

# Cleaning advice

Type of residue	Clean with	Cleaning advice
Light	Cleaning sponge and soft cloth	Wipe over the zone to be cleaned with a sponge and hot water, and then wipe off with a soft dry cloth.
Accumulated baked-on stains/dirt, sugar spills or melted plastics	Cleaning sponge or glass scraper and soft cloth	Wipe over the zone to be cleaned with a sponge and hot water, using a ceramic scraper to remove any large marks or stains and then wipe off with a soft dry cloth.
Rings and hard water residues	White vinegar and soft cloth	Pour a small amount of warm white vinegar onto the stain, leave it to stand, and then wipe off with a soft dry cloth.
Shiny metallic streaks	Cleaning agent for vitroc ceramic glass.	Use specialist vitroc ceramic glass cleaner (preferably one with silicone for its protective properties)

**5**

**YEAR  
PARTS**  
2 YEAR LABOUR

**For service or queries relating to your product please contact:**

The Customer Care Department on **01949 862 012** or email [customer.care@cda.co.uk](mailto:customer.care@cda.co.uk)

**For more information please contact:**

The Sales Department on **01949 862 010** or email [sales@cda.co.uk](mailto:sales@cda.co.uk)

**Customer Care Department.** The CDA Group Ltd, Harby Road, Langar, Nottinghamshire, NG13 9HY  
T: 01949 862 012 F: 01949 862 003 E: [customer.care@cda.co.uk](mailto:customer.care@cda.co.uk)