



FW381 integrated under counter freezer

Manual for Installation, Use and Maintenance

Important

The CDA Group Ltd cannot be held responsible for injuries or losses caused by incorrect use or installation of this product. Please note that CDA reserve the right to invalidate the guarantee supplied with this product following incorrect installation or misuse of the appliance.

This appliance is not designed to be used by people (including children) with reduced physical, sensorial or mental capacity, or who lack experience or knowledge about it, unless they have had supervision or instructions on how to use the appliance by someone who is responsible for their safety.

Under no circumstances should any external covers be removed for servicing or maintenance except by suitably qualified personnel.

Appliance information:

Please enter the details on the appliance rating plate below for reference, to assist CDA Customer Care in the event of a fault with your appliance and to register your appliance for guarantee purposes.

Appliance Model	
Serial Number	

CE Declarations of Conformity:

This appliance has been designed, constructed and marketed in compliance with safety requirements of EEC Directive 2006/95/EEC (Low voltage) and requirements of EMC Directive 2004/108/EEC.

This appliance has been manufactured to the strictest standards and complies with all applicable legislation, including Electrical safety (LVD) and Electromagnetic interference compatibility (EMC). Parts intended to come into contact with food conform to EEC/89/109.4

IMPORTANT INFORMATION FOR CORRECT DISPOSAL OF THE PRODUCT IN ACCORDANCE WITH EC DIRECTIVE 2002/96/EC.

At the end of its working life, the product must not be disposed of as urban waste. It must be taken to a special local authority differentiated waste collection centre or to a dealer providing this service.

Disposing of a household appliance separately avoids possible negative consequences for the environment and health deriving from inappropriate disposal and enables the constituent materials to be recovered to obtain significant savings in energy and resources. As a reminder of the need to dispose of household appliances separately, the product is marked with a crossed-out wheeled dustbin. 

Important

Never store inflammable or explosive items and strong corrosive acids or alkalis in the appliance.

This is a household appliance, which is produced in accordance with the national standard. It is intended for food storage only, not for storage of blood, medicine and biological products.

To prevent risk of fire, keep the appliance away from petrol or any other inflammables.

To prevent risk of electromagnetic interference or other accidents, do not place a microwave oven on top of the refrigerator or use any electric appliance inside the refrigerator.

Do not allow children to play with or near the appliance.

The internal surface of freezer compartment is very cold when the appliance is running. Do not touch the surface especially with wet hands.

Do not splash water onto the appliance. Keep it away from places of high humidity that may have adverse effect on the electric insulation performance.

Please remove the door, door seal and shelves before disposal of the old appliance and put them away in a safe place to prevent children from being entrapped.

Before first use

You must allow the freezer to settle for at least twenty four hours prior to switching the power on.

It is recommended that you clean the interior of the appliance prior to first use, using a solution of bicarbonate of soda and warm water and then thoroughly drying the interior.

The freezer may have an odour to it at first use. This will disappear as the appliance cools.

Please note:

The appliance will work continuously until it comes down to the correct temperature.

If the appliance is switched off, you should allow five minutes before switching it on again to prevent unnecessary damage to the compressor.

Never store inflammable or explosive items and strong corrosive acids or alkalis in the appliance.

Use

Freezer

- The freezer compartments are designed to store only frozen food.
- Never put hot or warm foods in the freezer, allow them to cool fully before putting them into the freezer.
- Follow the instructions on the food packaging for storage of frozen food. If no information is provided, foods should not be stored for more than three months after the purchase date.
- Store food in small packages (ideally less than 2.5kg). This reduces the freezing time and improves the quality of the food after thawing.
- Wrap food before putting into the freezer. To stop the wrapping sticking together, ensure it is dry.
- Label the food before freezing with information including type of food and dates of storage and expiry.
- Once food is thawed, it must not be refrozen unless it has been completely cooked. Only defrost as much food as is required to prevent wastage.
- Bottled or canned drinks should not be stored in the freezer compartment as they could explode.
- Only open the door for as long as is necessary. Leaving the door open for long periods will affect the temperature inside the appliance and waste energy.
- Ensure all compartments are fully closed after use.

Control panel

Thermostat dial

The thermostat can be set between ● (least cold) and 5 (coldest)

When introducing large amounts of fresh food into the freezer, turn the thermostat dial to position 5. After 24 hours, return the thermostat dial to its usual position.

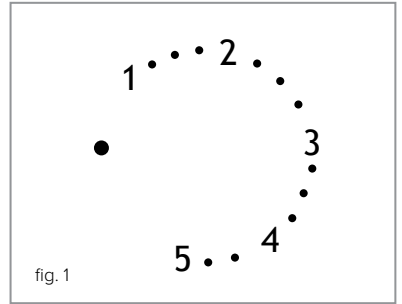

Defrosting the freezer

Do not use heaters or defrosting sprays in this appliance.

- Never use any metallic or sharp objects to remove the ice as this could damage the lining.
- The freezer compartment should be defrosted regularly to ensure the most efficient running of the freezer.
- Once the ice is more than 5mm thick, the freezer should be defrosted.
- First remove the freezer drawers.
- To speed up the process, place a bowl of warm water in the base of the freezer compartment.

Once defrosting is complete, dry the inside of the freezer compartment with a sponge or clean cloth.

The freezer should be cleaned using a solution of bicarbonate of soda and lukewarm water. Do not use abrasive products or detergents. After washing, rinse and dry thoroughly.

Clean the drawers separately by hand with soap and water. Do not put them in the dishwasher.

Once cleaning is complete, then reconnect the power.

Troubleshooting

If you have any problems with your appliance, you should check the troubleshooting prior to calling CDA Customer Care to prevent unnecessary service calls and potential cost.

If the appliance is not working

- Check there is power to the appliance:
- The house fuses are intact and the fuse in the plug has not blown.
- The thermostat is not set to ● (off position).
- The plug socket is functioning fine. To check this, plug another electrical appliance in to see if the socket is working.
- The temperature of the room is adequate (16°C or above).

The appliance is working, but not very well

- The appliance is not overloaded.
- The thermostat is set to an appropriate temperature.
- The door is closing properly.
- The cooling system at the rear of the appliance is clean and free of dust, and not touching the rear wall
- There is enough ventilation at the side and rear walls.
- The temperature of the room is adequate (16°C or above).

The appliance is noisy

- The appliance is level and stable.
- The side and rear walls are clear, and there is nothing resting on the appliance.
- The cooling gas in the refrigerator will make a slight bubbling noise, even when the compressor is not running.

Installation

This appliance must never be installed close to heat sources i.e. heating elements, radiators, cookers or in damp places.

The appliance should be mounted on a piece of wood (for example a section of worktop or kitchen carcass) if a raised floor is to be fitted, if the kitchen floor is to be tiled after installation, or if the installation height of the appliance is greater than 850 mm.

Contents and Tools Required

Fig. 2 - Installation kit contents

1. Wood screw (17 pcs)
2. Decor door fixing bracket
3. Decor door base fixings (2 pcs)
4. Decorative cover
5. Screw
6. Top bracket

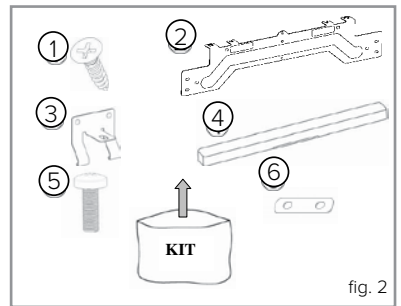

fig. 2

Fig. 3 - Tools required

7. Spirit level
8. Spanner
9. Setsquare
10. Flathead screwdriver

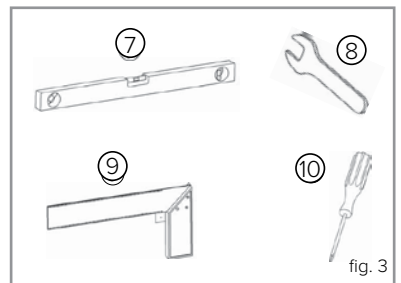

fig. 3

Installation

Fig. 3 - Dimensions of the appliance

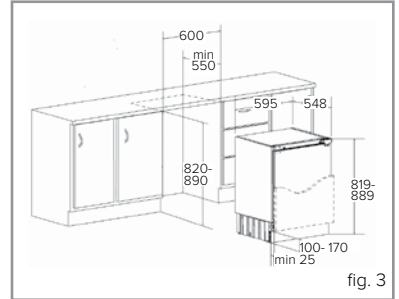

Fig. 4 - Fitting the worktop bracket

Remove the screw (5) on the top of the appliance, locate the top bracket(6) and fix the bracket with screw(5).

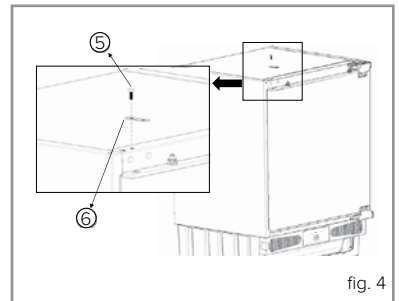
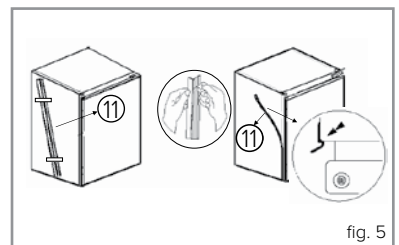

Fig. 5 - Fitting the spacer piece

Take out the spacer piece (11) located on the side panel and remove the protective tape. Stick the spacer piece on the opposite side to the door hinges of the appliance.



Installation

Fig. 6 - Adjusting the appliance height

The height of the appliance can be adjusted by the help of adjustable feet to fit the furniture height. Use a spirit level to ensure the appliance is level.

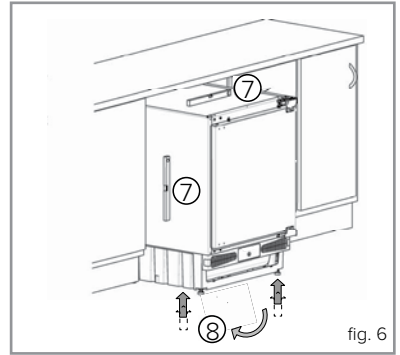

Fig. 7 - Aligning the appliance

Slide the appliance into the kitchen unit and align the hinge surface with front surface of the kitchen unit.

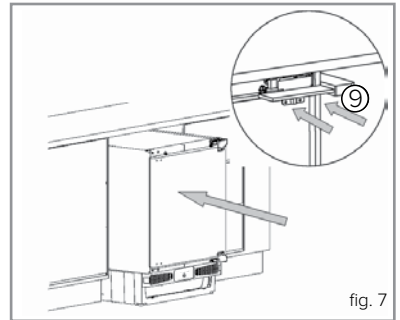
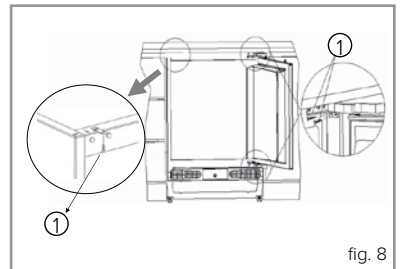

Fig. 8 - Fixing the appliance

Screw the hinges and metal bracket to the kitchen unit using screws (1).



Installation

Fig. 9 - Fitting the decor door bracket

Unscrew and remove the nuts and washers from the appliance door. Place fixing bracket on the appliance door by inserting the holes to adjustment bolts.

Dimension B= Measure from the underside surface of kitchen unit to the bottom of fixing bracket.

Dimension C= Measure from the underside surface of kitchen unit to the top of next unit door.

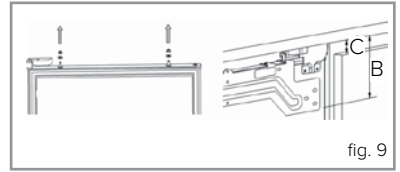

Fig. 10 - Fitting the decor door bracket

Subtract C from B and put the fixing bracket (2) in place using this measurement for vertical position and place to the centre for horizontal position. Secure the fixing bracket (2) using screws(1).

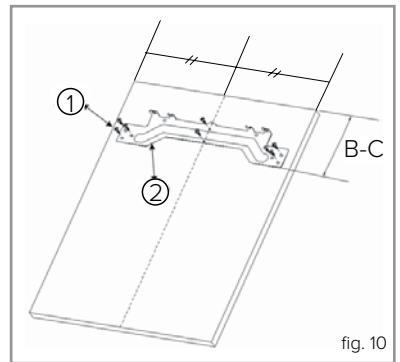
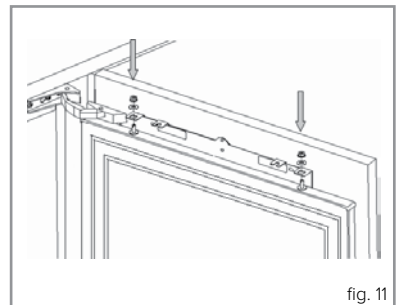

Fig. 11 - Fitting the decor door

Place the decor door onto the appliance door by inserting adjustment bolts into the slots on the fixing bracket. Locate the washers and screw the nuts onto the adjustment bolts.



Installation

Fig. 12 - Aligning the decor door

Close the door and check the alignment with the other unit doors. Adjust the decor door by screwing or unscrewing the adjustment bolts for vertical adjustment and by the help of the slots on the fixing bracket for other directions. Lock the screws into place as shown in 10.2.

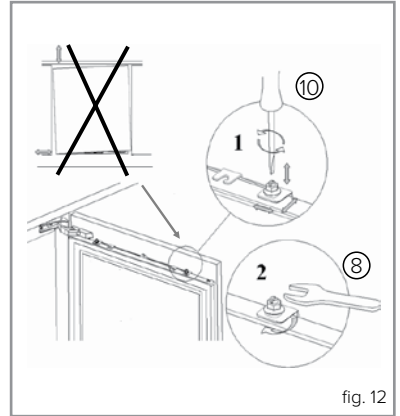

Fig. 13 - Fitting the decor door base fixings

With the appliance door open, remove the screws at the bottom of the appliance door. Locate the decor door base fixings (3) and screw the fixings to the appliance door and the decor door.

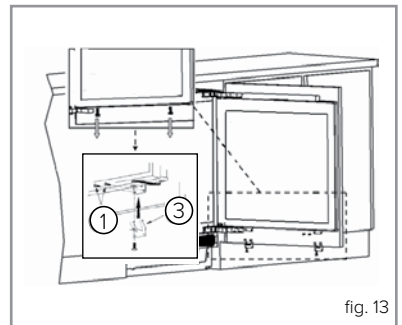
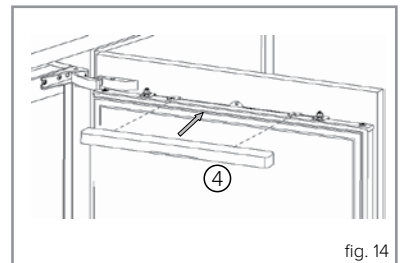

Fig. 14 - Fitting the decorative cover

Fit the decorative cover (4) on the decor door fixing bracket.



Installation

Fig. 17 - Fitting the plinth

Fit the plinth section, providing minimum 25 mm gap between the cabinet door and fix it.

Never cover over the ventilation slots.

Once installed the plinth must not block the ventilation slots in the appliance.

This may require cutting the plinth down. Failure to ensure adequate ventilation may invalidate the warranty.

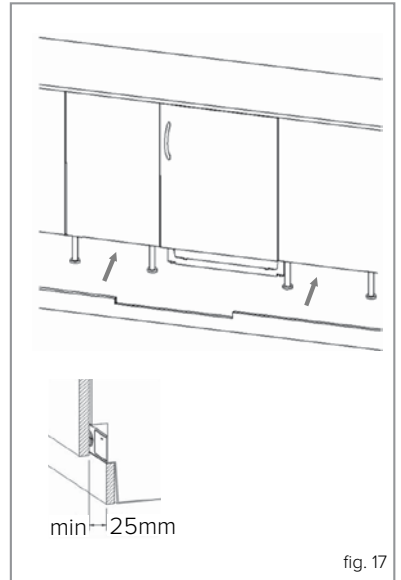
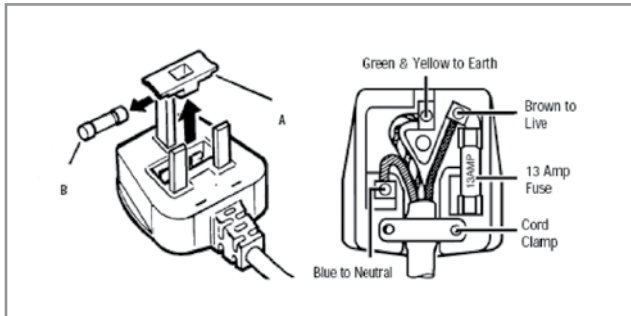

fig. 17

Electrical information

Warning! This appliance must be earthed.



The mains lead of this appliance has been fitted with a BS 1363A 13 amp fused plug. To change a fuse in this type of plug, follow the steps below:

1. Remove the fuse cover and fuse.
2. Fit replacement 13A fuse, ASTA approved to BS 1362 type, into the fuse cover.
3. Replace fuse cover.

Important: Do not use the appliance without the fuse cover in position.

How to connect an alternative plug

If the fitted plug is not suitable for your socket outlet, then it should be cut off and disposed of safely to prevent the risk of electric shock. A suitable alternative plug of at least 13 Amp rating to BS 1363 should be used.

As the colours of the wires in the mains lead of this appliance may not correspond with the coloured markings identifying the terminals in your plug, proceed as follows:

- The wire which is coloured GREEN and YELLOW must be connected to the terminal which is marked with letter (E) or by the Earth symbol \perp or coloured GREEN and YELLOW.
- The wire which is coloured BLUE must be connected to the terminal which is marked with the letter (N), or coloured BLACK.
- The wire which is coloured BROWN must be connected to the terminal which is marked with the letter (L) or coloured RED.

If in doubt regarding the electrical connection of this appliance, consult a qualified electrician. Do not shorten the supply cable, the appliance may require removing for servicing.

N.B. Ensure that the plug socket is situated in an easily accessible place.

If the power supply cord is damaged, it must be replaced by a CDA authorised agent.



Please contact our Customer Care Department, or for Service on the details below.

Customer Care Department • The CDA Group Ltd. • Harby Road • Langar • Nottinghamshire • NG13 9HY
T : 01949 862 012 F : 01949 862 003 E : service@cda.eu W : www.cda.eu