

# EVPC9 Extractor

Manual for Installation, Use and Maintenance



**|C|D|A|**



## Important

The manufacturer cannot be held responsible for injuries or losses caused by incorrect use or installation of this product. Please note that the manufacturer reserves the right to invalidate the guarantee supplied with this product following incorrect installation or misuse of the appliance or use in a commercial environment.

This appliance is not designed to be used by people (including children) with reduced physical, sensorial or mental capacity, or who lack experience or knowledge about it, unless they have had supervision or instructions on how to use the appliance by someone who is responsible for their safety.

Under no circumstances should any external covers be removed for servicing or maintenance except by suitably qualified personnel.

### Appliance information:

Please enter the details on the appliance rating plate below for reference, to assist CDA Customer Care in the event of a fault with your appliance and to register your appliance for guarantee purposes.

Appliance Model

Serial Number

### CE Declarations of Conformity:

This appliance has been manufactured to the strictest standards and complies with all applicable legislation, including Gas safety, Electrical safety (LVD) and Electromagnetic interference compatibility (EMC).

### IMPORTANT INFORMATION FOR CORRECT DISPOSAL OF THE PRODUCT IN ACCORDANCE WITH EC DIRECTIVE 2002/96/EC.

At the end of its working life, the product must be taken to a special local authority waste collection centre or to a dealer providing appliance recycling services. Disposing of a household appliance separately avoids possible negative consequences for the environment and health. It also enables the constituent materials to be recovered, saving both energy and resources. As a reminder of the need to dispose of household appliances separately, the product is marked with a crossed-out wheeled dustbin 

### Please note:

- Under no circumstances should the extractor be connected to any gas ventilation system, flue system or hot air ducting system.
- Do not vent the extractor into an attic or loft space.
- Only house the extractor in rooms with adequate ventilation. Remember that the extractor is powerful and whatever air is extracted needs to be replaced.
- Do not tile the extractor in. It should be removable for service or maintenance.
- Do not use silicone sealant to secure the hood to the wall.
- You must be able to isolate the extractor from the mains electrical supply after installation.
- Steam cleaners must not be used when cleaning this appliance.
- The performance of your extractor will vary depending on a number of factors. These include: type of extraction, length of ducting, room volume, ventilation available and cleanliness of the filters.

## Using your Extractor

For best performance, you should switch on the extractor 15 minutes before starting to cook and leave it to run for approximately 15 minutes after the end of cooking.

### Control Panel

- A - Light key
- B - Decrease speed key
- C - Display
- D - Increase speed key
- E - Timer key

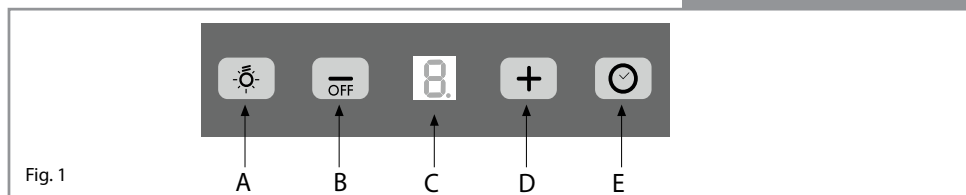

Fig. 1

### To switch the extractor light on and off

- Touch key A.

### To switch on the extractor

- Touch either key B or D. The appliance will switch on at the first speed.
- To increase the speed touch key D.
- To switch the extractor off, touch and hold key B for two seconds when the extractor is working at higher speeds, or touch key B at speed one.

### The intensive function

- The extractor is equipped with an intensive function which runs for ten minutes before returning to the previous selected speed. To activate the intensive function, touch key D at speed three. The display will blink whilst the intensive function is on.

### The timer

- The extractor is equipped with a timer that allows the extractor to run for 15 minutes before switching off automatically.
- To activate the timer, touch key E. The display will flash a decimal point when the timer is on.

### Please note

The timer cannot be activated when the intensive function is on.

### The clean air function

- The extractor is equipped with a clean air function that switches on the motor for ten minutes every hour at speed one.
- To activate the clean air function, touch key E for two seconds when the appliance is off. To return to normal function, touch either key B or D. To switch off the clean air function, touch key E. The display C will light up in sections whilst the motor is running, and will show the letter C during the fifty minutes when the motor is not running.

## Care and Maintenance

**IMPORTANT : DO NOT PERFORM MAINTENANCE OR CLEANING OF THE EXTRACTOR WITHOUT FIRST SWITCHING OFF THE ELECTRICITY SUPPLY.**

### Cleaning

You should use a nonabrasive cleaner. Any abrasive cleaner (including Cif) will scratch the surface and could erase the control panel markings.

You can clean your extractor effectively by simply using a dilute solution of water and mild detergent and drying to a shine with a clean cloth.

### Cleaning the grease filter

The grease filters should be kept clean to minimise the risk of fire.

When the display flashes alternating the speed selected with the letter A, or at least once a month, you should remove and clean the grease filters with hot soapy water. You can also wash the grease filters in a dishwasher, ensuring that you place it in an upright position to prevent damage from other items in the dishwasher. After rinsing and drying, replace the filters. After the grease filters has been replaced, the electronic memory must be reset by touching key A for approximately five seconds, until the letter A stops flashing.

To remove the grease filters follow the steps below:

1. Pull open the handle on the grease filter as shown in fig 2. It will release at the handle side.
2. Then lower the grease filter to remove it completely.

To replace the grease filters, repeat the steps in reverse.

Please note:

Cleaning the grease filter in the dishwasher may lead to discolouration. This is normal and does not constitute a fault with the appliance.

### Changing the charcoal filter (re-circulating only)

When the display flashes alternating the speed selected with the letter F, the charcoal filters must be replaced. After the charcoal filter has been replaced, the electronic memory must be reset by touching key A for approximately five seconds, until the letter F stops flashing.

To attach a new charcoal filter, first remove the grease filters as described above. Then offer up the charcoal filter to body of the extractor as shown in figure 3. Repeat with the other charcoal filter. Then replace the grease filters.

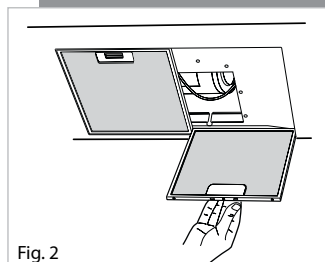

Fig. 2

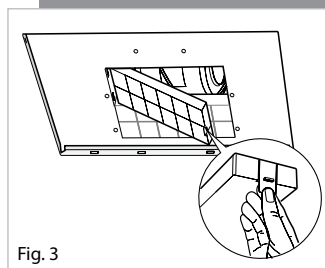

Fig. 3

## Changing the Light

DO NOT CHANGE THE LIGHT BULB IMMEDIATELY AFTER USE AS THE BULB WILL BE HOT. ALLOW IT TO COOL BEFORE REMOVING IT.

Unscrew the light bulb cover, please see figure 4. Unscrew the light bulb and replace with a 12V 20W halogen light bulb. Finally, replace the light bulb cover.

Do not touch bulbs or adjacent areas during or straight after prolonged use of the lights.

The light is designed for use during cooking and not for general room illumination. Extended use of the light can reduce the life span of the bulb.

Bulb replacement is not covered by the guarantee.

Only use bulbs recommended for your extractor. Do not fit bulbs of a higher power rating.

Bulbs of a lower power rating may be adequate for use, generally last longer and use less energy.

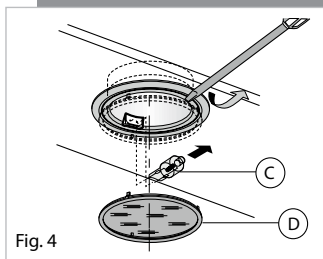

Fig. 4

## Mains Electricity Connection

THIS APPLIANCE MUST BE CONNECTED TO THE MAINS SUPPLY BY A COMPETENT PERSON, USING FIXED WIRING VIA A DOUBLE POLE SWITCHED FUSED SPUR OUTLET AND PROTECTED BY A 3A FUSE.

We recommend that the appliance is connected by a qualified electrician, who is a member of the N.I.C.E.I.C. and who will comply with the I.E.E. and local regulations.

The wires in the mains lead of this appliance are coloured in accordance with the following code:

BLUE = NEUTRAL, BROWN = LIVE.

As the colours of the wires in the mains lead for the appliance may not correspond with the coloured markings identifying the terminals connecting to the fused spur, proceed as follows:

- The wire which is coloured blue must be connected to the terminal marked N (Neutral), or coloured black.
- The wire which is coloured brown must be connected to the terminal marked L (Live), or coloured red.

NOTE: USE A 3A FUSE

Assembly and electrical connection should be carried out by competent personnel.

When installing this product we recommend you seek the help of another individual.

**IMPORTANT: THIS APPLIANCE IS A CLASS II APPLIANCE (DOUBLE INSULATED) AND IS NOT INTENDED TO BE EARTHED. DO NOT FIT AN EARTH LEAD TO THIS EXTRACTOR.**

Do not mount the isolation switch behind the chimney section. It is a requirement that you must be able to isolate the extractor from the mains electrical supply after installation.

This appliance is intended to be connected to the mains electrical supply by means of an isolation switch and fused spur and is intended to be protected by a 3A fuse. The use of a 13A fuse can cause damage to the internal wiring in the event of a fault, and may also invalidate the warranty.

DOUBLE POLE SWITCHED  
FUSED SPUR OUTLET

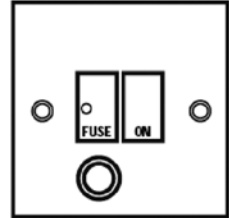

USE A 3 AMP FUSE



## Electrical Information

Mains electrical voltage: 230 – 240Vac, 50Hz

Total rated power consumption:

310W

## Troubleshooting

If your extractor is not working:

1. Check that the mains supply has not been switched off.
2. Check that the fuse in the spur has not blown.

## Mounting your Extractor

When the extractor is to be installed above a hob, the minimum distance between the hob and extractor must exceed 650mm.

If the instructions provided with your gas hob state that the required distance between the hob and extractor must be greater than 650mm, then that is the distance that should be observed; this is a legal requirement and may lead to your hob being disconnected from the gas supply and the installation being reported to RIDDOR (The height should be measured from the top of the burners).

IN THE ABSENCE OF ANY INSTRUCTIONS SUPPLIED WITH THE GAS HOB, THE MINIMUM DISTANCE BETWEEN THE HOB AND EXTRACTOR MUST BE AT LEAST 760mm.

The width of any hob must not be greater than the width of the extractor installed above it. Fig. 5

## Ducting and Ventilation

For best performance and lowest noise output, we recommend the use of 125mm or 150mm ducting. You can also use 100mm ducting but this will reduce performance.

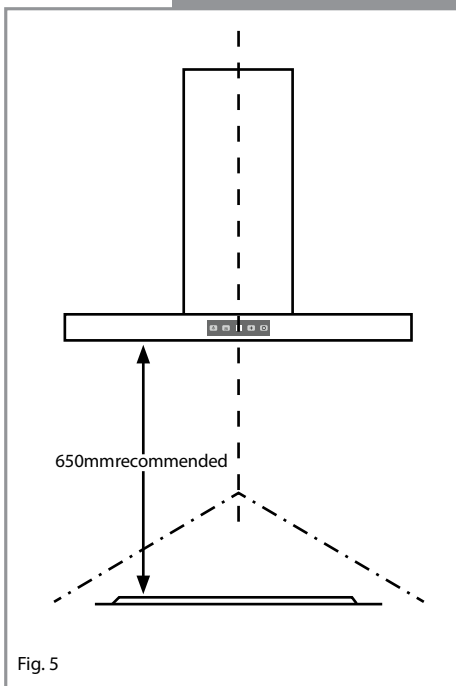



## Installation

It is important that wall plugs and screws are selected that are suitable for the wall type you will be fixing the extractor to. CDA will not be liable for any issue arising from the use of unsuitable plugs and screws.

The extractor is mounted to the wall using brackets and support rails. To install the product onto the wall, proceed as follows: -

1. Position the template (D) on the wall and mark the positions of the drill holes on the wall. Note that the bottom edge of the template should be the height required above the hob. (Fig 6 2A)
2. Drill holes suitable for the wall plugs you are using and fix the support rails (E) and brackets (C) to the wall using suitable screws (F). (Fig 6 2B)
3. With the help of another individual lift the appliance and slot it into the support rails (A), as shown (Fig 7)
4. Secure the extractor to the top brackets (C) using the supplied screws (E). The extractor is now secured to the wall. (Fig 8)

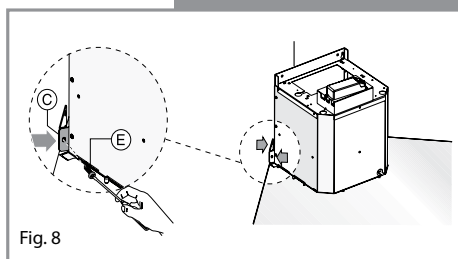
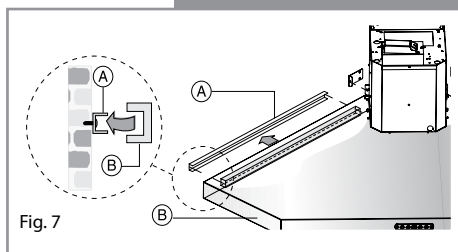
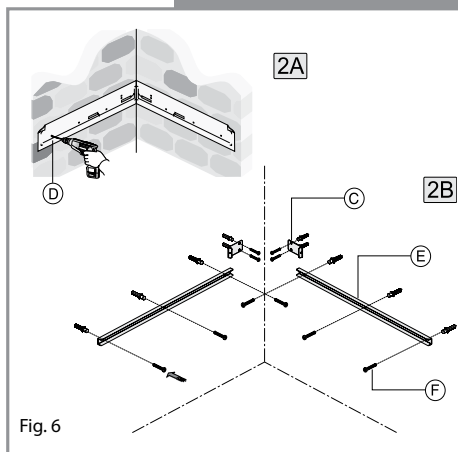

## Installation

5. Using the chimney top support bracket as a guide, mark the hole positions on the wall and ceiling at the required positions (Fig 9 5A & B), drill and fit the bracket to the wall and ceiling, using appropriate fixings (D & E).
6. If venting the extractor outside, connect the vent adaptor to the ducting pipe as shown if (Fig 10); If using the extractor as a re-circulation device, assemble the vent diverter and connect the ducting and vent adaptor as shown in Fig 11.
7. Fit the chimney sections (Y) and secure to the chimney support bracket (C) using the two provided screws (X) as shown in Fig 8.
8. Drill and insert 2 plugs suitable for use with the wall type into the holes and fix the bracket with 2 screws.
9. Fit the chimney section and secure to the mounting bracket with the supplied screws (fig 12).

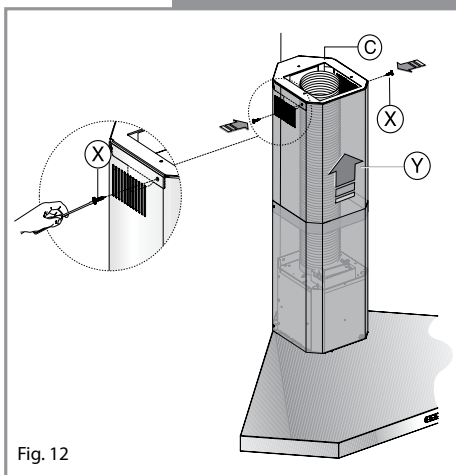
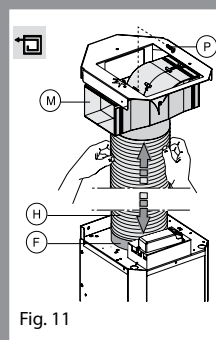
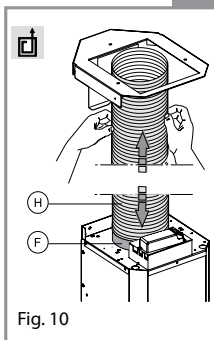
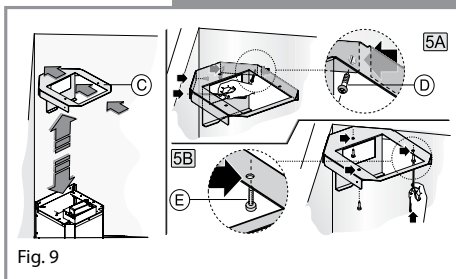

## Energy Efficiency Information

Attribute	Symbol	Value	Units
Model Identification		evpc9	
Annual Energy Consumption	$AEC_{Hood}$	119.6	kWh
Time increase factor	f	1.4	
Fluid Dynamic Efficiency	$FDE_{Hood}$	16.1 (D)	
Energy Efficiency Index	$EEl_{Hood}$	92.9 (D)	
Measured airflow at Best Efficiency Point	$Q_{BEP}$	347.6	$m^3/h$
Measured Pressure at Best Efficiency Point	$P_{BEP}$	244.0	Pa
Maximum airflow	$Q_{MAX}$	520.0	$m^3/h$
Measured electric power at Best Efficiency Point	$W_{BEP}$	146.3	W
Nominal lighting power	WL	60.0	W
Average illumination of the lighting system on the cooking surface	$E_{Middle}$	369.0	Lux
Measured power consumption in standby	$P_S$	1.0	W
Measured power consumption off mode	$P_O$	NA	W
Sound power level	$L_{WA}$	64.0	dBA
Grease Filter Efficiency	$GFE_{Hood}$	72 (D)	%
Lamp efficiency	$LE_{Hood}$	6.2 (F)	%



To contact our Customer Care Department, or for Service,  
please contact us on the details below.