

VC801 Built-In Coffee Machine

Installation, Use and Maintenance



Safety Instructions

The appliance is not intended for use by persons (including children) with reduced physical, sensory or mental capabilities, or lack of experience and knowledge, unless they have been given supervision or instruction concerning use of the appliance by a person responsible for their safety.

Children should be supervised to ensure that they do not play with the appliance.

Cleaning and user maintenance shall not be made by children without supervision.

Never immerse the appliance in water.

This is a household appliance only. It is not intended to be used in:

- Staff kitchen areas in shops, offices and other working environments;
- Farm houses;
- By clients in hotels, motels and other residential type environments;
- Bed and breakfast type environments.

If the plug or power cable is damaged, it must be replaced by customer services only to avoid all risk.

For European Markets Only:

This appliance can be used by children aged from 8 years and above if they have been given supervision or instruction concerning use of the appliance in a safe way and if they understand the hazard

involved. Cleaning and user maintenance shall not be made by children unless they are older than 8 and supervised. Keep the appliance and its cord out of the reach of children aged less than 8 years.

Appliances can be used by persons with reduced physical, sensory or mental capabilities or lack of experience and knowledge if they have been given supervision or instruction concerning use of the appliance in a safe way and understand the hazards involved.

Children shall not play with the appliance.

When not in use and before cleaning, always unplug the appliance.



Surfaces marked with this symbol become hot during use (the symbol is present in certain models only).

Important Notes:

This appliance is designed solely to produce coffee and steam. Other types of use are not permitted and may prove dangerous. The CDA Group Ltd will not be held liable for any damage caused by incorrect use of the appliance.

- Read the user instructions carefully before using the appliance for the first time.
- To protect against fire, electrical shock and injury to persons, do not immerse cord or plugs in water or other liquid.
- The use of accessory attachments not recommended by The CDA Group Ltd may result in fire, electric shock or injury.

- Never touch the appliance with damp hands.
- Never touch the plug with damp hands.
- Make sure the socket used is freely accessible at all times, enabling the appliance to be unplugged when necessary.
- Unplug directly from the plug only. Never pull the power cable as you could damage it.
- To disconnect the appliance completely, place the main switch (A23) on the side of the appliance in the “0” position.
- If the appliance is faulty, do not attempt to repair; turn it off using the main switch (A23), unplug from the mains socket and contact Customer Services.
- Keep all packaging (plastic bags, polystyrene foam) away from children.
- This appliance produces hot water; steam may form while it is in operation. Avoid contact with splashes of hot water or hot steam. Use knobs and handles.
- Do not grab the coffee maker when it is out of the cabinet.
- Do not rest vessels containing liquids, inflammable or corrosive materials on top of the appliance. Place accessories required to make coffee safely aside (the measure for coffee may be placed in the special holder).
- Do not rest large objects which could obstruct movement or unstable objects on the appliance.
- Do not use the appliance when extracted. Make sure the appliance is inactive before extracting it. The only exception is adjusting the coffee mill which must be done with the machine out (see the section “Adjusting the Coffee Mill”).

-
- **This coffee machine is not designed for use with caramelised coffee beans: Use of such beans will invalidate the guarantee.**

Note: This appliance has a cooling fan. This may switch on when coffee, steam or hot water is delivered. After several minutes the fan switches off automatically.

Do not manually switch the coffee machine off or disconnect the power supply while the fan is still running.

Important

The CDA Group Ltd cannot be held responsible for injuries or losses caused by incorrect use or installation of this product. Please note that CDA reserve the right to invalidate the guarantee supplied with this product following incorrect installation or misuse of the appliance.

Under no circumstances should any external covers be removed for servicing or maintenance except by suitably qualified personnel.

Appliance information:

Please enter the details on the appliance rating plate below for reference, to assist CDA Customer Care in the event of a fault with your appliance and to register your appliance for guarantee purposes.

Appliance Model	
-----------------	--

Serial Number	
---------------	--

CE Declarations of Conformity:

This oven has been designed, constructed and marketed in compliance with safety requirements of EEC Directive 2006/95/EEC (Low voltage) and requirements of EMC Directive 2004/108/EEC.

This appliance has been manufactured to the strictest standards and complies with all applicable legislation, including Electrical safety (LVD) and Electromagnetic interference compatibility (EMC). Parts intended to come into contact with food conform to EEC/89/109.4.

IMPORTANT INFORMATION FOR CORRECT DISPOSAL OF THE PRODUCT IN ACCORDANCE WITH EC DIRECTIVE 2002/96/EC.

At the end of its working life, the product must not be disposed of as urban waste. It must be taken to a special local authority differentiated waste collection centre or to a dealer providing this service.

Disposing of a household appliance separately avoids possible negative consequences for the environment and health deriving from inappropriate disposal and enables the constituent materials to be recovered to obtain significant savings in energy and resources. As a reminder of the need to dispose of household appliances separately, the product is marked with a crossed-out wheeled dustbin. 

Legend for Fig.A

- A1 Cup tray
- A2 Service door
- A3 Coffee guide
- A4 Waste coffee container
- A5 Brewing unit
- A6 Cup tray lights
- A7 ON/Stand-By button
- A8 Control panel
- A9 IEC connector
- A10 Cappuccino maker (removable)
- A11 Cappuccino maker nozzle
- A12 Water tank
- A13 Coffee spout (adjustable height)
- A14 Drip tray
- A15 Bean container lid
- A16 Bean container
- A17 Grinding adjustment knob
- A18 Pre-ground coffee funnel door
- A19 Measure
- A20 Compartment for measure
- A21 Pre-ground coffee funnel
- A22 Power cable
- A23 Main switch
- A24 Tray

Description of the control panel

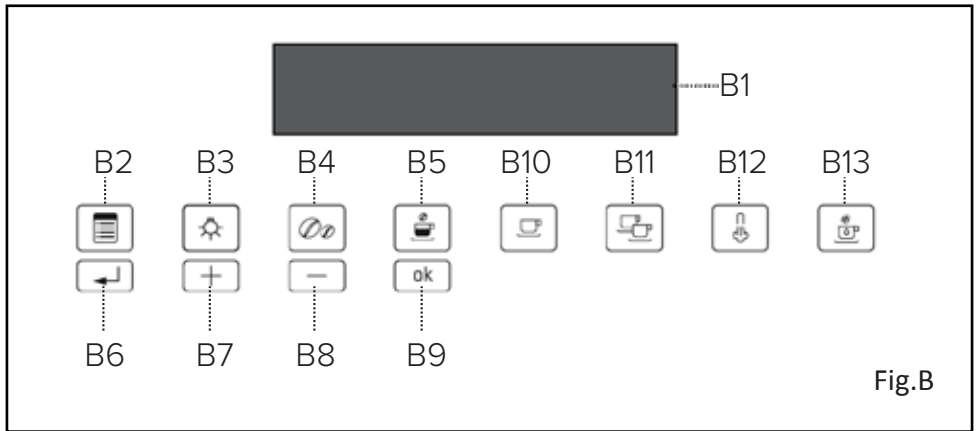

Note: Only the buttons available for use with the currently selected function will be lit on the touch screen.

A light touch is enough to activate the buttons.

- B1 Display
- B2 Activate or deactivate the settings menu
- B3 Switch the light (A6 on Fig.1) on and off
- B4 Select the coffee strength
- B5 Select the size of coffee (espresso, small cup, medium cup, large cup, mug)
- B6 Exit the selected mode
- B7 Scroll forwards through the menu to display options available
- B8 Scroll backwards through the menu to display options available
- B9 Confirm the selected function
- B10 Dispense a single cup of coffee
- B11 Dispense 2 cups of coffee
- B12 Operate the steam dispenser
- B13 Operate the hot water dispenser

Using the Appliance for the First Time

Notes:

Coffee has been used to factory test the appliance and it is therefore completely normal for there to be traces of coffee in the mill.

Connect the appliance to the mains supply.

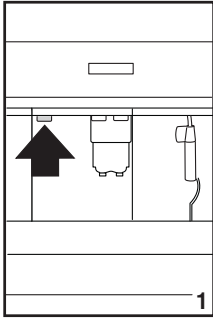

Switch the appliance on using the ON/Standby button (A7).

To Set the Required Language:

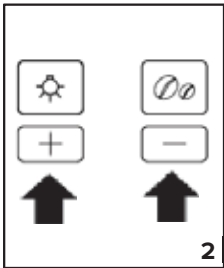

Press the Settings Menu button (B2).

Use the “+” & “-“ buttons (B7 and B8) to choose the required language (fig. 2).

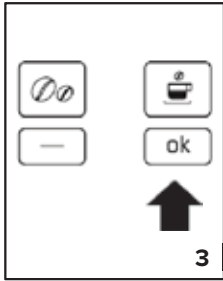

To select English language:

When the message “PRESS OK TO CHOOSE ENGLISH” is displayed, press the “ok” button (B9) (fig. 3) for 3 seconds until “ENGLISH INSTALLED” is displayed.

Options for alternative languages are displayed in the menu in those specific languages.

Approximately 5 seconds after first switching on the coffee machine, it displays the message “FILL TANK”.



Extract the water tank (fig. 4), rinse and fill with fresh water, without exceeding the MAX line.

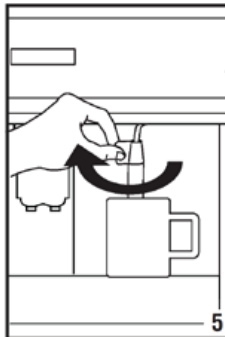

Replace and push it in as far as it will go.

Note: When the message “FILL TANK” is displayed the coffee machine will lock and not respond to any buttons. The machine automatically unlocks when the tank is filled and replaced in position.

Place a cup under the cappuccino maker (fig. 5).

The appliance displays: “HOT WATER PRESS OK”.

Press the “ok” button (B9) (fig. 3) and after a few seconds a little water comes out of the cappuccino nozzle and a little rinsing water is ejected from the coffee nozzles.



The machine then displays “TURNING OFF... PLEASE WAIT” and switches off.

Extract the appliance by pulling it out using the handles (fig. 6).

Open the lid and fill the container with coffee beans, then close the lid and push the appliance back into place.

The coffee maker is now ready for normal use.

Notes:

When using the appliance for the first time, you need to make 4-5 cups of coffee and 4-5 cappuccinos before the appliance gives satisfactory results.

Important: Never introduce pre-ground coffee, freeze dried coffee, caramelised beans or anything else which could damage the appliance into the bean container.

Important: Always switch off using the ON/Standby button (A7) before either switching off the ON/OFF switch (A23) or disconnecting the electrical power supply. This allows it to perform a SELF-DIAGNOSIS cycle and rinse the coffee spouts prior to switching off. To turn it on again, press the ON/Standby button (A7) (fig. 1).

Adjust the water hardness setting as soon as possible after installation, see instructions in the “Setting Water Hardness” section (page 35).

Turning On and Heating Up

Each time the appliance is turned on, it performs an automatic preheat and rinse cycle which cannot be interrupted. The appliance is ready for use only after completion of this cycle.

Danger of Scalding: During rinsing, a little hot water flows from the coffee spouts.

To turn the appliance on, press the ON/OFF/Stand-By button (A7) (fig. 1), the message “HEATING UP... PLEASE WAIT” is displayed.

When heating is complete, the message changes to “RINSING” and hot water is rinsed through the coffee spouts.

The message “MEDIUM CUP NORMAL TASTE” is displayed when the coffee machine has reached normal operating temperature.

If no button is pressed within approx. 2 minutes, the time is displayed, if set (see the “Setting The Clock” section). If the time has not been set, the appliance displays the last functions set.

When any button is pressed, “MEDIUM CUP NORMAL TASTE” is displayed and the appliance is ready to make coffee again.

Making Coffee Using Whole Coffee Beans

The appliance is preset to make coffee with “normal” strength. You can also choose coffee with an “extra-mild”, “mild”, “strong” or “extra-strong” flavour. There is also a pre-ground coffee option.

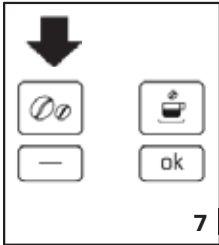

To choose the required Strength, press the coffee strength button (B4) (fig. 7) several times to scroll through the options.

The current coffee strength setting is displayed.

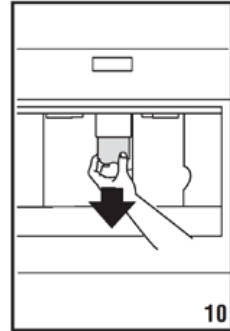
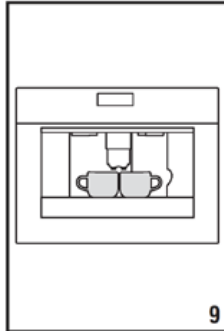
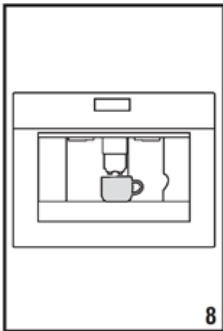

Place 1 cup under the spouts to make 1 coffee (fig. 8), or 2 cups for 2 coffees (fig. 9).

Lower the spouts as near as possible to the cup(s) for a creamier coffee (fig. 10).

The appliance is preset to make coffees of varying sizes. You can choose between “espresso”, “small cup”, “medium cup”, “large cup” or “mug”.

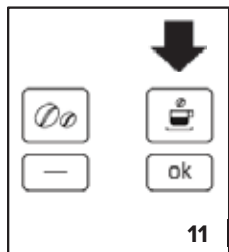

Press the cup size button (B5) (fig. 11) several times to scroll through the options.

The current cup size setting is displayed.

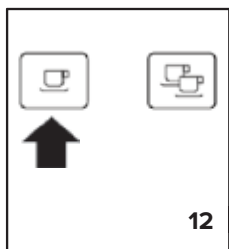

Press the single cup button (B10) (fig.12) if you want to make a single coffee or the double cup button (B11) (fig.13) if you want to make 2 coffees.

The appliance now grinds the beans and starts delivering the coffee into the cup.

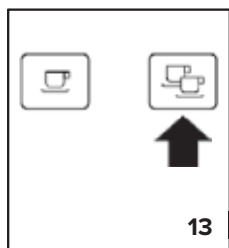

Once the set amount of coffee has been delivered, the machine stops delivery automatically and expels the exhausted waste coffee into the waste coffee container.

After a few seconds, the appliance is ready for use again.

To turn the appliance off, press the ON/Stand-By button (A7) (fig. 1). Before switching off, the appliance performs an automatic rinse cycle (Take care to avoid scalds).

Note 1: If the coffee is delivered a drop at a time or not at all, see the “Adjusting the Coffee Mill” section.

Note 2: If the coffee is delivered too fast and the cream is not satisfactory, see the “Adjusting the Coffee Mill” section.

Note 3: Tips for a hotter coffee:
Proceed as described in the section “Changing And Setting Menu Parameters”, “Rinse” function.

Unless preheated, do not use excessively thick cups as they will absorb too much heat.

Preheat the cups by rinsing them with hot water.

Note 4: Coffee delivery can be interrupted at any moment by re-pressing the previously selected button, which remains lit during the operation.

Note 5: When the appliance displays “FILL TANK”, fill the tank with water or the appliance will not deliver coffee (It is normal for there to be a little water left in the tank).

Note 6: After about 14 single (or 7 double) coffees, the appliance displays “EMPTY WASTE COFFEE CONTAINER”.

Even if not full, the “EMPTY WASTE COFFEE CONTAINER” message is displayed 72 hours after the first coffee has been delivered. For the 72 hours to be calculated correctly, the machine must never be turned off with the main switch in the “0” position.

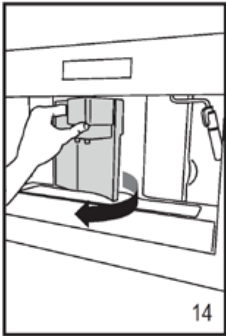

To clean, open the service door on the front of the appliance by pulling the spout (fig. 14).

Extract the drip tray (fig. 15) and clean it.

When cleaning, always extract the drip tray completely.

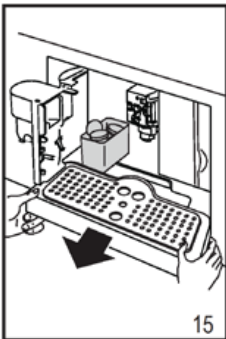

Important: When extracting the drip tray, the waste coffee container **MUST** always be emptied, even if it is not completely full. If this is not done, when you make the next coffees the container may over-fill and the machine may be clogged.

Note 7: Never extract the water tank while the machine is delivering coffee. If it is removed, it will not be possible to make the coffee and the appliance will display “GROUND TOO FINE ADJUST MILL AND PRESS OK” and then “FILL TANK”.

It is then necessary to check the level of water in the tank and replace it in the appliance.

To turn the machine back on again, press the “ok” button (B9),

“HOT WATER PRESS OK” is displayed. Press the “ok” button (B9) within a few seconds and deliver water from the cappuccino maker for about 30 seconds.

When delivery stops, the machine should be ready for use again.

Note: The coffee maker may request the operation to be repeated a number of times until the air is completely eliminated from the water pipes.

Note: If this operation is not performed correctly or if the machine is turned off, the basic modes may be displayed, although the problem is in fact still present.

Changing the Quantity of Coffee in the Cup

The coffee machine is preset by default to automatically make the following types of coffee:

- Espresso
- Small cup
- Medium cup
- Large cup
- Mug

To Change the Quantity:

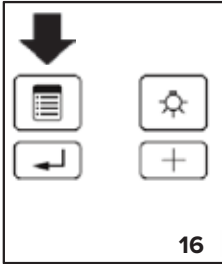

Press the Settings Menu button (B2) to enter the menu (fig. 16).

Press the “+” & “-“ buttons (B7) and (B8) (fig.2) to scroll through the menu until “PROGRAM COFFEE” is displayed.

Press the “ok” button (B9) to select it.

Press the “+” & “-“ buttons (B7) and (B8) (fig.2) to scroll through the menu until the type of coffee you want to change is displayed.

Press the “ok” button (B9) to confirm the type of coffee you want to change.

Use the “+” & “-“ buttons (B7) and (B8) to change the quantity of coffee. The progress bar shows the quantity of coffee selected.

Press the “ok” button (B9) again to confirm (or the  button (B6) to cancel the operation).

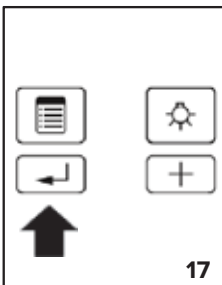

Press the  button (B6) (fig. 17) twice to exit the menu.

The appliance is now reprogrammed with the new settings and is ready for use.

Adjusting the Coffee Mill

The coffee mill is preset in the factory and should not require adjusting. However, if after making the first few coffees you find that delivery is either too fast or too slow (a drop at a time), this can be corrected by adjusting the grinding adjustment knob (fig. 18).

Important: The grinding adjustment knob must only be turned when the coffee mill is in operation.



For slower delivery and creamier coffee, turn one click anticlockwise (finer coffee grinding).

For faster delivery (not a drop at a time), turn one click clockwise (coarser coffee grinding).

Making Coffee Using Pre-Ground Beans

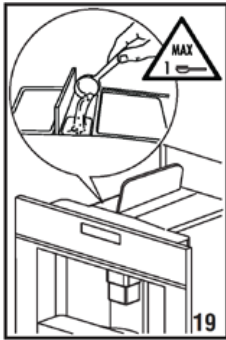

Press the Coffee Strength button (B4) (fig. 7), scroll through the options and select the “pre-ground coffee” function.

Extract the machine by pulling it forwards using the handles. Lift the central lid, place one measure of pre-ground coffee in the funnel (fig. 19), push the appliance in then proceed as described in the section “Making Coffee Using Coffee Beans”.

Note: You can just run the machine through one single cycle at a time (1 or 2 cups) by pressing the appropriate button.

After using the machine with pre-ground coffee, to go back to making coffee using beans, deactivate the pre-ground coffee function by pressing the Coffee Strength button (B4) (fig. 7).

Note 1: Never introduce pre-ground coffee when the machine is switched off or it could spread through the inside of the appliance.

Note 2: Never add more than 1 measure of pre-ground coffee beans at a time, otherwise the appliance will not make coffee.

Note 3: Use the measure provided only.

Note 4: Use only pre-ground coffee for espresso coffee machines in the funnel.

Note 5: If more than one measure of pre-ground coffee is used and the funnel clogs, push the coffee down with a blunt object then remove and clean the brewing unit and machine as described in the “Cleaning the Brewing Unit” section.

Delivering Hot Water

Ensure the appliance is switched on and is ready for use.

Turn the cappuccino nozzle outwards and place a container underneath it (fig. 5).

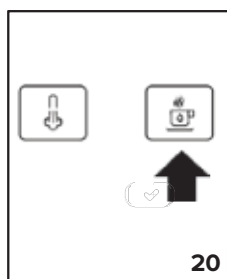

Press the Hot Water Dispenser button (B13) (fig. 20).
The appliance displays: “HOT WATER PRESS OK”.

Press the “ok” button (B9) again and hot water is delivered from the cappuccino nozzle into the container underneath.

You should not deliver hot water for more than 2 minutes at a time.

To interrupt, press the Hot Water Dispenser button (B13) or the  button (B6).

Hot water dispensing stops once the set quantity is reached.

Changing the Quantity of Hot Water

The machine is set by default to automatically deliver 200ml of hot water.

To change these quantities, proceed as follows:

Place a container underneath the cappuccino nozzle (fig. 5).

Press the Settings Menu button (B2) to enter the menu (fig. 16) then press the “+” & “-“ buttons (B7) and (B8) (fig. 2) until “PROGRAM HOT WATER” is displayed.

Press the “ok” button (B9) to confirm.

Select the required quantity of water by pressing the “+” & “-“ buttons (B7) and (B8). The progress bar shows the quantity of water selected.

Press the “ok” button (B9) to confirm (or the  button (B6) to cancel the operation).

Press the  button (B6) (fig. 17) twice to exit the menu.

The appliance is now reprogrammed with the new settings and is ready.

Making Cappuccino (Using the Steam Function)

Swing the cappuccino nozzle towards the left (fig. 5).

Pour approx. 100g of milk (for each cappuccino to be made) into a container and place it under the cappuccino nozzle. Ensure the container is large enough to contain the froth after the milk has doubled or tripled in volume. We recommend the use of semi-skimmed milk straight from the fridge.

Press the Steam Dispenser button (B12) (fig. 21). “STEAM PRESS OK” is displayed.

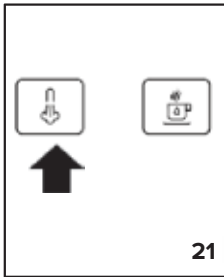

Press the “ok” button (B9).

To interrupt steam delivery press the Steam Dispenser button (B12) again or the  button (B6).

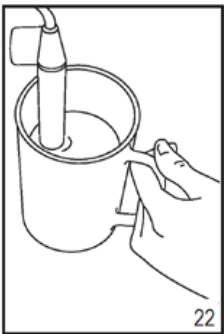

Insert the cappuccino nozzle into the milk container (fig. 22), taking care not to immerse it for more than half its length.

For a creamier froth, insert the cappuccino nozzle into the milk, move the container slowly up and down.

You should not deliver steam for more than 2 minutes at a time.

When the required temperature is reached, stop the steam delivery by pressing the Steam Dispenser button (B12) again, or the  button (B6).

Make the coffee as described above using sufficiently large cups then fill them with the frothed milk prepared previously.

Important: Always clean the cappuccino system immediately after use as described in the “Cleaning” section below.

Cleaning

Warning: Before performing any cleaning operations, the machine must be turned off by pressing the main switch (A23) and unplugged from the mains power supply.

Never immerse the coffee maker in water.

Cleaning the Cappuccino Maker

Important: To ensure hygienic operation of the appliance, we recommend you carry out this procedure each time you make cappuccino, thus avoiding stale milk remaining in the nozzle.

Place an empty container under the cappuccino nozzle.

Press the Steam Dispenser button (B12) and then press the “ok” button (B9) to discharge steam for a few seconds. This empties the steam pipes of all traces of milk.

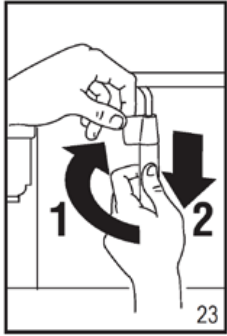

Wait for the cappuccino maker to cool down, then holding the cappuccino maker lever firmly in one hand, unscrew the cappuccino outer nozzle with the other, turning it anticlockwise and removing it downwards (fig. 23).

Remove the cappuccino maker inner nozzle by pulling it downwards.

Wash the inner and outer nozzles thoroughly in hot water.

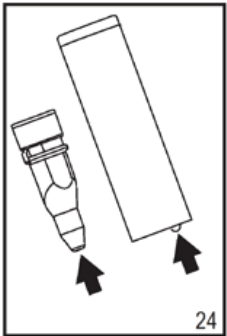

Make sure the holes in the inner and outer nozzle tips (fig.24) are not blocked. If necessary, clean with a pin or cocktail stick.

Replace the inner nozzle by inserting it upwards onto its housing.

Replace the outer nozzle by pushing it upwards and rotating it clockwise.

Cleaning the Coffee Maker

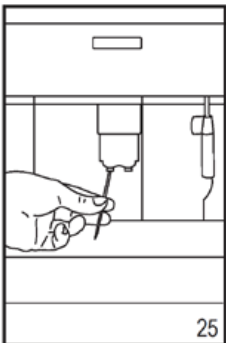

Do not use solvents or abrasive detergents to clean the coffee maker. A soft damp cloth will suffice.

Never wash any of the components of the coffee maker in the dishwasher.

The following parts of the machine must be cleaned regularly:

- Waste coffee container (A4).
- Drip tray (A14).
- Water tank (A12).
- Coffee spout (A13) (Fig.25), hot water spout (A11) and cappuccino maker spout (A10).
- Pre-ground coffee funnel (A21).
- Inside of the machine, accessible after opening the service door (A2).
- Brewing unit (A5).

Cleaning the Waste Coffee Container

When “EMPTY WASTE COFFEE CONTAINER” is displayed, the waste coffee container must be emptied and cleaned.

To clean, open the service door on the front of the appliance (fig. 14), extract the drip tray (fig. 15) and clean.

Clean the waste coffee container thoroughly.

Important: Whenever the drip tray is extracted, the waste coffee container must always be emptied.



Cleaning the Drip Tray

Important: If the drip tray is not emptied the water might overflow. This could damage the machine.

The drip tray is fitted with a level indicator (red) showing the level of water it contains (fig. 26).

Before the indicator protrudes from the cup tray, the drip tray must be emptied and cleaned.

To remove the tray, open the service door (fig. 14) and remove the drip tray with the waste coffee container (fig. 15).

Clean the drip tray and waste coffee container (A4).

Replace the drip tray and waste coffee container (A4).

Close the service door.

Cleaning the Water Tank

Clean the water tank (A12) regularly (approx. once a month) with a damp cloth and a little mild washing up liquid.

Remove all traces of washing up liquid before reusing the water tank.

Cleaning the Nozzles

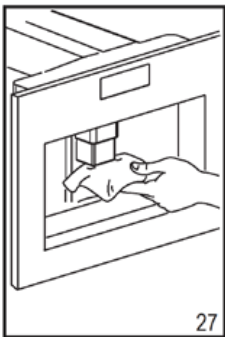

Clean the nozzles periodically using a sponge (fig. 27).

Check regularly that the holes in the coffee spout are not blocked. If necessary, remove coffee deposits with a cocktail stick (fig. 25).

Cleaning the Pre-Ground Coffee Funnel

Check regularly (approx. once a month) that the pre-ground coffee funnel is not blocked.

Cleaning the Inside Of The Coffee Maker

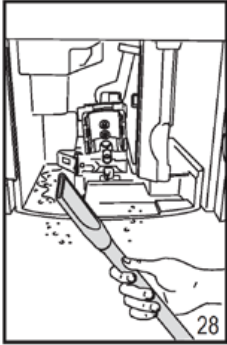

Check regularly (about once a week) that the inside of the appliance is not dirty. If necessary, remove coffee deposits with a sponge.

Allow to dry and then remove the residues with a vacuum cleaner (fig. 28).

Cleaning the Brewing Unit

The brewing unit must be cleaned at least once a month.

Before removing the brewing unit for cleaning, ensure the machine is correctly turned off (see “Turning the Appliance Off”).

Important: The brewing unit (A5) must not be removed when the appliance is on. Do not use force to remove the brewing unit.

Open the service door (fig. 14).

Remove the drip tray and waste coffee container (fig. 15).

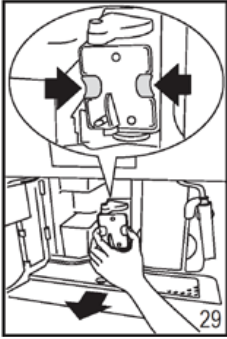

Squeeze the two red release buttons inwards and at the same time pull the brewing unit outwards (fig. 29).

Important: Do not use washing up liquid to clean the brewing unit. It would remove the lubricant applied to the inside of the piston.

Soak the brewing unit in water for about 5 minutes, then rinse.

After cleaning, replace the brewing unit (A5) by sliding it onto the internal support and pin at the bottom, then push the “PUSH” symbol fully in until it clicks into place.

Note: If the brewing unit is difficult to insert, ensure the piston is fully inserted by pressing it firmly from the bottom and top as shown here:

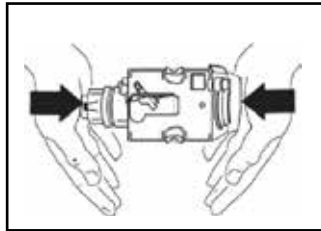

Once inserted, make sure the two red buttons have snapped out.

Replace the drip tray and waste coffee container.

Close the service door.

Changing and Setting Menu Parameters

When the appliance is switched on (but not producing coffee/steam/hot water), you can use the internal menu to modify the following parameters and functions:

- Choose language
- Rinsing
- Shut-off time
- Set clock
- Start time
- Auto-start
- Temperature
- Water hardness
- Program coffee
- Program jug
- Program water
- Descale
- Reset to default
- Statistics
- Contrast
- Buzzer

Setting the Language

To change the language on the display, proceed as follows:

Press the Settings Menu button (B2) to enter the menu. “CHOOSE LANGUAGE” is displayed.

Press the “ok” button (B9) to select the option.

Press the “+” & “-“ buttons (B7) and (B8) until the required language is displayed.

Press the “ok” button (B9) to confirm.

Press the  button (B6) to exit the menu.

Rinsing

This function enables you to pre-heat the brewing unit to obtain hotter coffee. Proceed as follows:

If more than 2/3 minutes have passed since the last coffee was made, before requesting another coffee, the brewing unit should be pre-heated.

Press the Settings Menu button (B2) to enter the menu then press the “+” & “-“ buttons (B7) and (B8) to select the “RINSING” function.

Press the “ok” button (B9). “RINSING... PLEASE CONFIRM” is displayed.

Press the “ok” button (B9) again to rinse the coffee nozzles.

Deliver the water into the drip tray below, or alternatively use this water to preheat the cup to be used, then empty it before making coffee.

Note: It is particularly useful to pre-heat the cup if making a small coffee.

Changing the Shut-Off Time

The appliance is set by default to turn itself off automatically ½ hour after the last coffee has been made. This period can be adjusted to 1 or 2 hours by the user.

Press the Settings Menu button (B2) to enter the menu then press the “+” & “-“ buttons (B7) and (B8) to select the “SHUT-OFF TIME” function.

Press the “ok” button (B9) to confirm.

Press the “+” & “-“ buttons (B7) and (B8) to select the time after which the appliance will go off (½ hour, 1 hour, 2 hours).

Press the “ok” button (B9) to confirm.

Press the  button (B6) to exit the menu.

Setting the Clock

Press the Settings Menu button (B2) to enter the menu then press the “+” & “-“ buttons (B7) and (B8) to select the “SET CLOCK” function.

Press the “ok” button (B9) to confirm.

Use the “+” & “-“ buttons (B7) and (B8) to set the hour then press the “ok” button (B9) to confirm.

Use the “+” & “-“ buttons (B7) and (B8) to set the minutes then press the “ok” button (B9) to confirm.

Press the  button (B6) to exit the menu.

Setting an Auto-Start Time

This option programmes the time the machine will switch on automatically.

Make sure the clock on the appliance has been set correctly.

Press the Settings Menu button (B2) to enter the menu then press the “+” & “-“ buttons (B7) and (B8) to select the “START TIME” function.

Press the “ok” button (B9) to confirm.

Use the “+” & “-“ buttons (B7) and (B8) to set the auto-start hours then press the “ok” button (B9) to confirm.

Use the “+” & “-“ buttons (B7) and (B8) to set the auto-start minutes then press the “ok” button (B9) to confirm.

Use the “+” & “-“ buttons (B7) and (B8) to activate the auto-start function until “AUTOSTART” is displayed then press the “ok” button (B9) to confirm.



The  symbol appears on the display.

Press the  button (B6) to exit the menu.

To Deactivate the Auto-Start Function

Press the Settings Menu button (B2) to enter the menu then press the “+” & “-“ buttons (B7) and (B8) to select AUTO START-UP”.

Press the “ok” button (B9) to confirm.

Press the  button (B6) to deactivate and the  symbol will disappear.

Changing Coffee Temperature

Press the Settings Menu button (B2) to enter the menu then press the “+” & “-“ buttons (B7) and (B8) to select the “TEMPERATURE” function.

Press the “ok” button (B9) to confirm.

Press the “+” & “-“ buttons (B7) and (B8) to select the required temperature between “Low”, Medium” & “High”.

Press the “ok” button (B9) to confirm the temperature selected.

Press the  button (B6) to exit the menu.

Setting Water Hardness

The coffee maker is factory set to provide a descale warning after a certain period of use. This can be adjusted to match your local water hardness as follows:

Remove the “Total Hardness Test” strip (supplied with the machine) from its packaging, dip it fully into fresh tap water for a few seconds, then remove and wait about 30 seconds (until it changes colour and forms red squares). Note the number of red squares visible on the test strip.

On the coffee maker, press the Settings Menu button (B2) to enter the menu then press the “+” & “-“ buttons (B7) and (B8) to select the “WATER HARDNESS” function.

Press the “ok” button (B9) to confirm.

Press the “+” & “-“ buttons (B7) and (B8) until the number coincides with the number of red squares on the test strip (e.g. if there are 3 red squares on the test strip, select the message “WATER HARDNESS 3”).

Press the “ok” button (B9) to confirm.

The coffee maker is now programmed to provide the descale warning when actually necessary.

Programming Coffee

For instructions on programming coffee, see the “Changing The Quantity Of Coffee In The Cup” section.

Programming Water

For instructions, see the “Changing The Quantity Of Hot Water” section.

Descaling

Important: Descaler contains acids. Read and obey the safety warnings provided by the manufacturer and given on the descaler pack.

Note: Use the descaler recommended by the manufacturer only. Use of other descalers invalidates the guarantee. Failure to descale the appliance as described also invalidates the guarantee.

When “PLEASE DESCALE !” is displayed, the machine requires descaling. Proceed as follows:

Press the Settings Menu button (B2) to enter the menu then press the “+” & “-” buttons (B7) and (B8) to select the “DESCALE” function. Press the “ok” button (B9) and the appliance displays “DESCALE PLEASE CONFIRM”.

Press the “ok” button (B9). The message “ADD DESCALER PLEASE CONFIRM” is displayed.

Empty the tank of water, pour the contents of the descaler bottle into the tank observing the instructions given on the descaler pack, then add water.

Position a container with a capacity of approx. 2 litres under the hot water spout.

Press the “ok” button (B9). Descaler flows out of the hot water spout into the container below. The appliance displays: “DESCALING”.

The descale programme automatically performs a series of deliveries and pauses.

After approx. 20 minutes “DESCALE COMPLETE PLEASE CONFIRM” is displayed.

Press the “ok” button (B9). “RINSING PLEASE CONFIRM” is displayed. Empty the water tank, rinse to eliminate any descaler residues, then fill with clean water.

Replace the tank full of clean water. “RINSING PLEASE CONFIRM” is displayed again.

Press the “ok” button (B9) again. Hot water flows out of the spout into the container below and “RINSING” is displayed.

Wait until “RINSING COMPLETE PLEASE CONFIRM” is displayed.

Press the “ok” button (B9). “DESCALE COMPLETE” is displayed, then “FILL TANK”. Fill the tank again with clean water.

The descale programme is now completed and the appliance is ready to make coffee again.

Note: If descaling is interrupted before completion, the process must be started again from the beginning.

IMPORTANT: FAILURE TO DESCALE THE APPLIANCE REGULARLY INVALIDATES THE GUARANTEE.

Resetting Default Values (Reset)

It is possible to return all user settings back to those when the machine left the factory.

Press the Settings Menu button (B2) to enter the menu then press the “+” & “-“ buttons (B7) and (B8) to select the “RESET TO DEFAULT” function.

Press the “ok” button (B9) and the appliance displays “RESET TO DEFAULT PLEASE CONFIRM”.

Press the “ok” button (B9) to reset the default values.

Statistics

This displays statistics relating to the machine. To display, proceed as follows:

Press the Settings Menu button (B2) to enter the menu then press the “+” & “-“ buttons (B7) and (B8) to select the “STATISTICS” function.

Press the “ok” button (B9) to confirm.

Press the “+” & “-“ buttons (B7) and (B8) to verify:

- How many coffees have been made.
- How many times the machine has been descaled.
- The total number of litres of water delivered.

Press the  button (B6) once to exit the function or twice to exit the menu.

Buzzer

This activates or deactivates the buzzer that sounds each time a button is pressed or an accessory is inserted/removed.

Note: The buzzer is active by default.

Press the Settings Menu button (B2) to enter the menu then press the “+” & “-“ buttons (B7) and (B8) to select the “BUZZER” function.

Press the “ok” button (B9), “BUZZER PLEASE CONFIRM” is displayed.

Press the  button (B6) to disable or the “ok” button (B9) to enable the buzzer.

Press the  button (B6) to exit the menu.

Adjusting Contrast

To increase or reduce the contrast of the display, proceed as follows:

Press the Settings Menu button (B2) to enter the menu then press the “+” & “-“ buttons (B7) and (B8) to select the “CONTRAST” function.

Press the “ok” button (B9) to confirm.

Press the “+” & “-“ buttons (B7) and (B8) until the required display contrast is reached. The progressive bar indicates the level of contrast selected.

Press the “ok” button (B9) to confirm.

Press the  button (B6) to exit the function or twice to exit the menu.

Turning the Appliance Off

Each time the appliance is turned off, it performs an automatic rinse cycle which cannot be interrupted.

Danger of scalds: During rinsing a little hot water flows from the coffee spouts. Avoid contact with splashes of water. To turn the appliance off, press the ON/Standby button (A7). The appliance performs the rinse cycle then goes off.

Note: If the appliance is not to be used for an extended period, place the main switch on the back of the appliance in the “0” position (A23).

Technical Specification

Voltage:	220-240 V [~] 50/60 Hz max. 10A
Power consumed:	1350 W
Max pressure:	15 bar
Water tank capacity:	1.8 litres
Size LxHxD:	595 x 455 x 401 mm
Weight:	23/24 kg

Displayed Messages

Displayed Message	Possible Cause	Remedy
FILL TANK	The water tank is empty or positioned incorrectly.	Fill the tank with water and/or insert it correctly, pushing it as far as it will go.
GROUND TOO FINE ADJUST MILL (alternating with) PRESS OK	The grinding is too fine.	Turn the grinding adjustment one click clockwise.
GROUND TOO FINE ADJUST MILL (alternating with) PRESS OK (then) FILL TANK	The tank has been removed during delivery.	Insert the tank and press the “ok” button (B9). “HOT WATER PRESS OK” is displayed. Press the “ok” button (B9) again. The appliance is ready to use.
CLOSE DOOR	The service door is open.	Close the service door.

Displayed Message	Possible Cause	Remedy
EMPTY WASTE COFFEE CONTAINER	The waste coffee container (A4) is too full or more than 3 days have passed since the machine last made coffee (this aids hygiene).	Empty the waste coffee container, clean it then replace. Important: when removing the drip tray the waste coffee container must be emptied, even if not completely full. If this is not done, the waste container may overflow, spill and block the machine.
INSERT WASTE COFFEE CONTAINER	After cleaning, the waste coffee container has not been replaced.	Open the service door and insert the waste coffee container.
ADD PRE-GROUND COFFEE	The “pre-ground coffee” function has been selected without placing any pre-ground coffee in the funnel. The funnel is blocked.	Extract the appliance and place pre-ground coffee in the funnel. Clean the funnel using a blunt object.

Displayed Message	Possible Cause	Remedy
PLEASE DESCALE!	The machine must be descaled.	The descaling procedure described in the "Descaling" section needs to be performed as soon as possible.
LESS COFFEE	Too much coffee has been used.	Reduce the quantity of pre-ground coffee then make the coffee again.
FILL BEAN CONTAINER	The coffee beans have run out.	Fill bean container.
INSERT BREWING UNIT	The brewing unit has not been replaced after cleaning.	Insert the brewing unit as described in the section "Cleaning the Brewing Unit".
GENERAL ALARM	The inside of the appliance is very dirty.	Clean the inside of the appliance as described in the section "Cleaning and maintenance".

Troubleshooting

Below is a list of some of the possible malfunctions.

If the problem cannot be resolved as described, contact Customer Services.

Problem	Possible Cause	Remedy
The coffee is not hot.	The cups were not preheated. The brewing unit has cooled down because 2/3 minutes have elapsed since the last coffee was made. The temperature is set too low.	Warm the cups by rinsing them with hot water. Before making coffee, preheat the brewing unit by selecting the “Rinsing” function on the menu. Change the set temperature.
The coffee is not creamy enough.	The coffee is ground too coarsely. Wrong type of coffee.	Turn the grinding adjustment one click anticlockwise while the coffee mill is running (fig. 11). Use a type of coffee for espresso makers.
The coffee is delivered too slowly or a drop at a time.	The coffee is ground too finely.	Turn the grinding adjustment one click clockwise while the coffee mill is running (fig. 11).

Problem	Possible Cause	Remedy
The coffee is delivered too quickly.	The coffee is ground too coarsely.	Turn the grinding adjustment one click anticlockwise while the coffee mill is running (fig. 11). Avoid turning the knob excessively as when 2 cups are selected the coffee delivery may be too slow. The effect is only visible after delivering two coffees.
Coffee does not come out of one of the spouts.	The spouts are blocked.	Clean the spouts with a toothpick (fig. 25).
The coffee does not come out of the spouts but from around the service door (A2).	The holes in the spouts are clogged. The coffee guide inside the service door is blocked and cannot swing.	Clean the spouts with a cocktail stick, sponge or stiff kitchen brush (fig. 25). Thoroughly clean the coffee guide (A3), particularly near the hinges.
Water comes out of the spouts instead of coffee.	The pre-ground coffee may be blocked in the funnel (A21).	Clean the funnel (A21) with a blunt object, clean the inside of the machine.

Installation

Initial Checks

After removing the packaging, make sure the product is complete, undamaged and that all accessories are present.

If the appliance is visibly damaged contact your supplier and do not use it.

Important

The packing pieces (plastic bags, polystyrene foam, etc.) should be kept out of reach of children.

Do not install the appliance in rooms where the temperature may drop to 0°C or lower.

Adjust the water hardness as soon as possible following the instructions in the “Setting Water Hardness” section (page 35).

Built-In Installation

Verify the minimum measurements required for correct installation of the appliance.

The coffee maker must be installed in a column and the column must be firmly fixed to the wall with commercially available brackets.

Important:

- All installation or maintenance operations must be performed with the appliance disconnected from the mains electricity supply.
- Kitchen furniture in direct contact with the appliance must be heat resistant (65°C min).

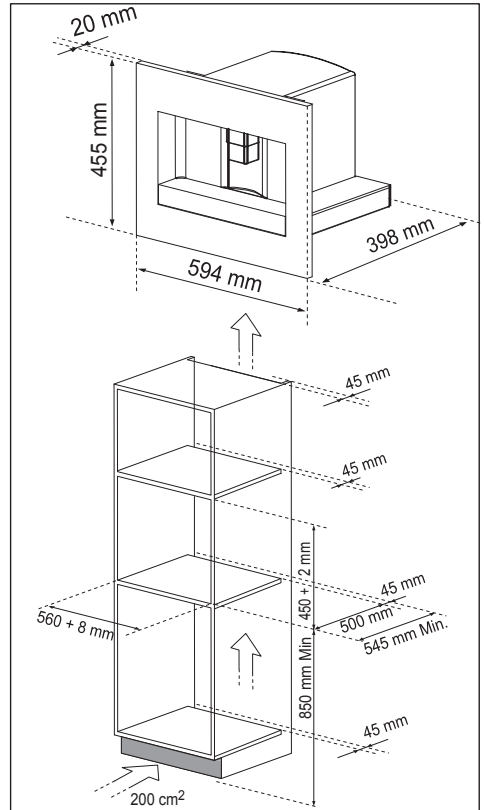

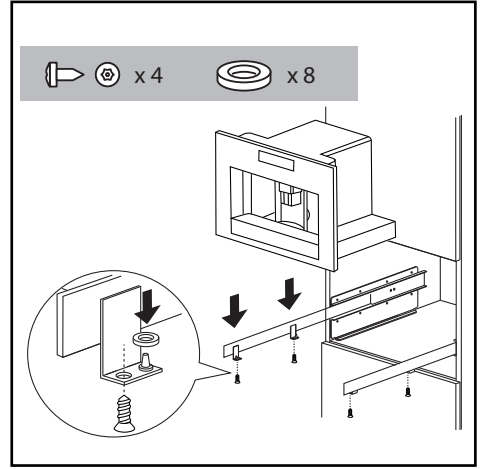
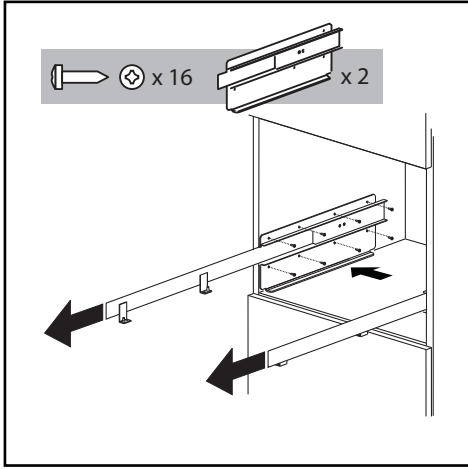

Position the rails on the sides of the cabinet as shown in the figure.

Fix with the screws, then extend the rails fully.

If the coffee maker is installed over a warmer drawer, use the top surface of this as a reference to position the rails. In this case, there will be no lower shelf to rest the rails on.

Position the appliance on the rails, making sure the pins are correctly inserted in the housings, then fix it with the screws supplied.

If the height of the appliance requires adjusting, use the spacer disks provided.

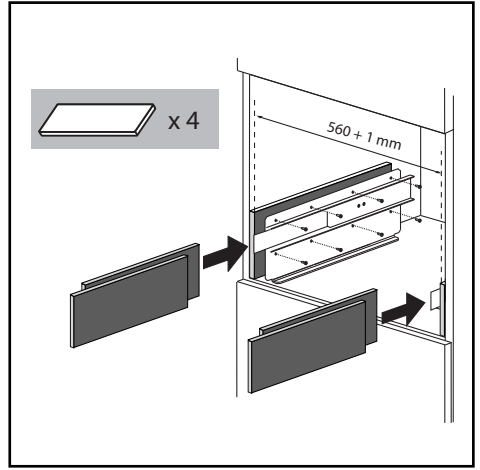
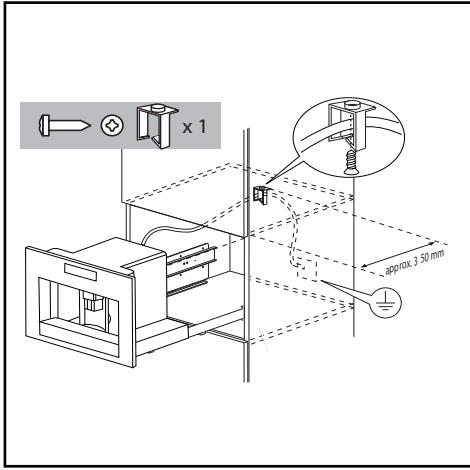

Fix the power cable with the clip.

The power cable must be long enough to allow the appliance to be extracted from the cabinet to fill the coffee bean container.

If necessary, correct alignment of the appliance by positioning the spacers supplied under or at the sides of the support.

Electrical Connection (UK Only)

If Your Appliance Comes Fitted With a Plug:

The plug will incorporate a 13 Amp fuse. If it does not fit your socket, the plug should be cut off from the mains lead, and an appropriate plug fitted, as below. **WARNING:** Very carefully dispose of the cut off plug after removing the fuse, do not insert in a 13 Amp socket elsewhere in the house as this could cause a shock hazard. If the plug is a moulded-on type, the fuse cover must be re-fitted when changing the fuse using a 13 Amp Asta approved fuse to BS 1362. In the event of losing the fuse cover, the plug must NOT be used until a replacement fuse cover can be obtained from your nearest electrical dealer. The colour of the correct replacement fuse cover is that as marked on the base of the plug.

If Your Appliance Is Not Fitted With a Plug:

Please follow the instructions provided below:

WARNING - THIS APPLIANCE MUST BE EARTHED

IMPORTANT

The wires in the mains lead are coloured in accordance with the following code:

Green and yellow:	Earth
Blue:	Neutral
Brown:	Live

As the colours of the wires in the mains lead may not correspond with the coloured markings identifying the terminals in your plug, proceed as follows:

The green and yellow wire must be connected to the terminal in the plug marked with the letter “E” or the earth symbol, or coloured green, or green and yellow.

The blue wire must be connected to the terminal marked with the letter “N” or coloured black.

The brown wire must be connected to the terminal marked with the letter “L” or coloured red.

Notes:

E & O E. All instructions, dimensions and illustrations are provided for guidance only. CDA reserve the right to change specifications without prior notice.



Please contact our **Customer Care Department** for Service on the details below

Customer Care Department

The ICDAI Group Ltd. • Harby Road • Langar • Nottinghamshire • NG13 9HY
T : 01949 862 012 F : 01949 862 003 E : customer.care@cda.eu

