

CI325 Integrated Washing Machine

Installation, Use and Maintenance



Important

This appliance must only be used for the purpose for which it is intended, i.e. domestic use. Any other use could be dangerous and may lead to premature failure of the appliance.

The CDA Group Ltd cannot be held responsible for injuries or losses caused by incorrect use or installation of this product. Please note that CDA reserve the right to invalidate the guarantee supplied with this product following incorrect installation or misuse of the appliance.

Under no circumstances should any external covers be removed for servicing or maintenance except by suitably qualified personnel.

Appliance information:

Please enter the details on the appliance rating plate below for reference, to assist CDA Customer Care in the event of a fault with your appliance and to register your appliance for guarantee purposes.

Appliance Model	
Serial Number	

CE Declarations of Conformity:

This appliance has been designed, constructed and marketed in compliance with safety requirements of EEC Directive 2006/95/EEC (Low voltage) and requirements of EMC Directive 2004/108/EEC.

IMPORTANT INFORMATION FOR CORRECT DISPOSAL OF THE PRODUCT IN ACCORDANCE WITH EC DIRECTIVE 2002/96/EC.

At the end of its working life, the product must not be disposed of as urban waste. It must be taken to a special local authority differentiated waste collection centre or to a dealer providing this service.

Disposing of a household appliance separately avoids possible negative consequences for the environment and health deriving from inappropriate disposal and enables the constituent materials to be recovered to obtain significant savings in energy and resources. As a reminder of the need to dispose of household appliances separately, the product is marked with a crossed-out wheeled dustbin. 

Safety Warnings

- If the plug or cord is damaged, do not connect the appliance to the mains power supply. If the cord is damaged it should be replaced by the manufacturer or appointed service agent in order to avoid a hazard.
- To remove the plug from the socket, pull on the body of the plug, not the cable.
- Do not plug the appliance in to the mains power supply with wet or damp hands.
- Never touch the appliance with wet hands or feet.
- Never open the detergent drawer when a programme is running.
- Never force the appliance door open when a programme is running.
- Since the appliance can reach high temperatures while running, do not touch the drain hose or drained water during draining.
- In case of any failure, first unplug the appliance and close the water tap.
- Repair on this appliance should only be undertaken by suitably qualified personnel.
- Keep the packing materials away from children to prevent risk of injury.
- Do not let children play with the washing machine.
- Keep pets away from the appliance.
- The appliance should not be installed on carpeted surfaces as this can block the air ventilation on the base.

Warnings

To avoid the risk of fire, electric shocks, injury or damage when using your washing machine, please take the following precautions:

- Please read all the instructions before using the washing machine.
- Do not wash items that have previously been cleaned, washed, soaked or treated with petrol, solvents for dry cleaning, other inflammable substances or explosives, as they produce fumes that could catch fire or explode.
- Do not add petrol, solvents for dry cleaning or other inflammable or explosive substances to the wash water as they produce fumes that could catch fire or explode.
- Do not repair or replace any part of the washing machine or try to carry out any type of servicing unless it is recommended in the maintenance instructions in the manual.
- Do not climb onto the machine or stand on the open porthole door.
- Do not use an extension lead or adaptor to connect your washing machine to the mains supply.
- Follow the washing instructions recommended by the manufacturer of the garment to be washed.
- Do not turn your washing machine on until you are sure that:
It has been installed in accordance with the installation instructions.
All the water, drainage, mains electricity and earth connections meet the local regulations and/or other applicable regulations.

Important: Ensure that the transit bolts have been removed prior to using the machine.

Recommendations

- Residues of detergent or softener left in the detergent drawer for long periods will dry and stick to the detergent drawer. To prevent this put the detergent and softener into the detergent drawer just before washing.
- It is recommended that the pre-wash programme should only be used for very dirty clothes.
- Do not exceed the maximum loading capacity.
- When the machine is not in use, keep the water tap closed.
- The appliance is not intended for use by people (including children) with reduced physical, sensory or mental capabilities, or lack of experience and knowledge, unless they have been given supervision or instruction concerning use of the appliance by a person responsible for their safety. Children should be supervised to ensure that they do not play with the appliance.
- If the appliance is not to be used for prolonged periods of time, unplug the appliance, close the water tap and leave the door ajar to keep the inside of the machine dry and to prevent unpleasant odours from developing.
- As a result of the quality control procedures during production, a certain amount of water may remain in the appliance. This is normal and does not signify a fault.
- Do not remove the rating plate. The information on it is important.
- This appliance should not be installed in locations where the ambient temperature may fall below 0°C. Use in ambient temperatures below 0°C may damage the machine.

Before First Use

When your washing machine has been correctly installed, we recommend that you pre-clean the machine.

This is to check that the installation, the connections and the drainage are all correct, and to thoroughly clean the inside of the washing machine before any wash programmes are run.

Prior to pre-cleaning you should ensure the transit bolts have been removed.

- Select the Cotton 90°C programme and add a normal dose of detergent into the detergent dispenser.
- Press the “Start / Pause” button.

Preparing Garments for Washing

- Wash lightly soiled garments using a short programme.
- Use a programme without prewash for medium-soiled garments.
- Wash heavily soiled garments using a long programme with prewash.
- Wash white and coloured loads separately.
- We recommend that small garments are placed in a wash bag.
- We recommend using the delicate programmes for sensitive fabrics.
- Separate clothes according to their types (cotton, synthetic, sensitive, woollen, etc.), required washing temperatures and level of dirtiness.
- Since new coloured clothes may shed dye on the first wash, wash them separately.
- Remove any metal pieces found on the items to be washed, for example curtain hooks.

-
- Fasten all zips and buttons.
 - Turn garments, such as knitted fabrics, inside out.
 - Before placing the clothes in the drum, make sure all the pockets are empty. Any small objects may block the drain pump.
 - We recommend loading the washing machine to its full capacity for best water and energy efficiency.
 - Whenever possible, we recommend that you wash garments of different sizes within the same wash programme. This improves the washing action and also aids the correct distribution of the garments in the drum when spin-drying, and the washing machine will therefore be quieter.

Detergents and Additives

Your washing machine's detergent dispenser has three sections as shown in figure 1.

Add the required amount of detergent and fabric softener into the specific sections of the detergent dispenser before starting the wash programme.

Note: Compartment 1 (Prewash) is only used with the “Intensive +” programme.

The detergent dispenser is designed to allow the use of liquid detergents rather than adding them to the drum. You should only insert liquid detergent into the main wash detergent compartment and ensure that concentrated liquid detergent is diluted with an equal quantity of water before use.

Liquid detergent should not be used on programmes with a prewash stage or when using the delay timer.

For wash loads that require pre-washing, add $\frac{1}{4}$ of the required powder detergent into the prewash section, and the remainder to the main detergent section.

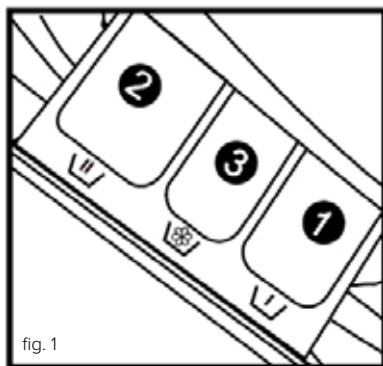

- 1 Prewash
- 2 Main Wash
- 3 Fabric Softener

Do not exceed the “MAX” level in the fabric softener section and ensure that concentrated fabric softeners are diluted before use for best washing results.

Remember that the amount of detergent to be used will always depend on:

- The amount of clothes to be washed.
- How heavily the clothes are soiled.
- The hardness of the water (Information on water hardness in your area can be obtained from your local water board).

We recommend the use of a decalcifying product if the water hardness is high in your area.

Eco Note

The use of more detergent than necessary will not improve your washing results, and will have a negative effect on the preservation of the environment.

We therefore recommend you follow the detergent manufacturer’s instructions.

Loading the Washing Machine

- Open the door.
- Add the items to be washed separately, ensuring they are loaded evenly.
- When closing the door, ensure that no item is trapped between the door and the door seal.
- Close the door securely, otherwise the programme will not start.

Control Panel

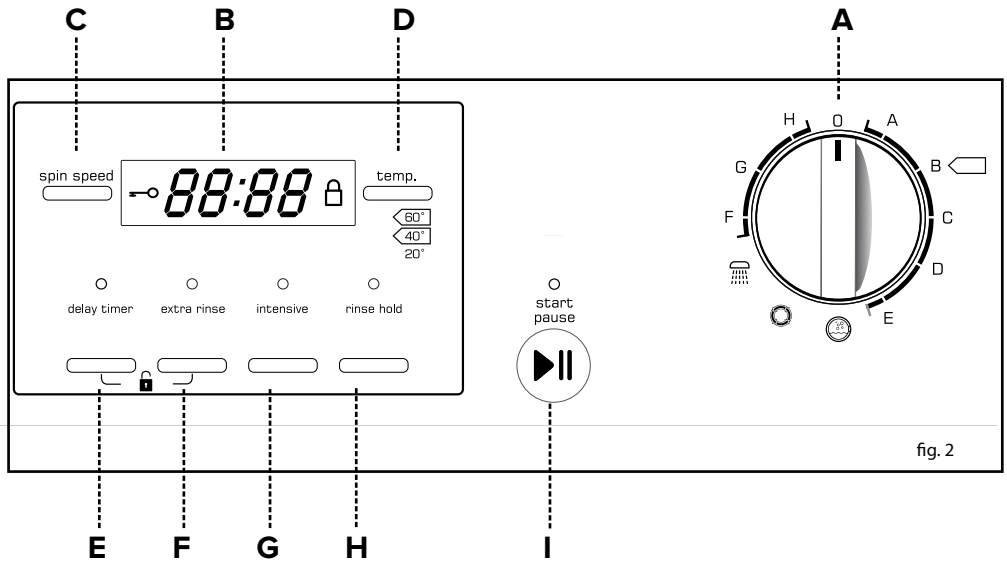

fig. 2

- A** Programme Selector
- B** Display
- C** Spin Speed Selection
- D** Wash Temperature
- E** Delay Timer Button
- F** Extra Rinse Button
- G** Intensive Button
- H** Rinse Hold Button
- I** Start / Pause Button

Starting a Wash Programme

- Turn the “Programme Selector” knob to the required programme.
- Select the required spin speed using the “Speed Speed” button.
- Select the wash temperature using the “Wash Temperature” button.
- Select any required extra options, as detailed below.
- Press the “Start / Pause” button.

When a wash programme is in progress, the programme can be paused by pressing the “Start / Pause” button at any time. To restart the programme, press the “Start / Pause” button again.

Programme selection

To select a programme, turn the “Programme Selector” knob to the required programme, as detailed in the programme listing below and also on the detergent dispenser. The display will show the programme duration.

Spin speed selection

Each selected programme has its own preset spin speed, as shown in the programme listing below.

If you press the “Spin Speed” button the currently set spin speed will show on the display. You can reduce this or switch it off completely if required by pressing the “Spin Speed” button a number of times. If you miss the speed you want you can come back round to it again by pressing a few more times.

A programme without final spin is used to prevent creasing when washing special fabrics.

Wash temperature selection

Each selected programme has its own preset wash temperature, as shown in the programme listing below.

If you press the “Wash Temperature” button the currently set temperature will show on the display. You can change the wash temperature if required by pressing the “Wash Temperature” button a number of times. If you miss the temperature you want you can come back round to it again by pressing a few more times.

Extra functions

Extra functions can be selected once the programme has been set. To select any extra function, press the required extra function button. The programme table on page 16 shows the functions available for each programme. The programme time shown on the display will reduce or increase, according to the extra functions selected.

Delay timer

A delay of up to 24 hours can be added to the end time in half hour increments to allow the wash programme to finish at a convenient time. The delay time is to the end of the wash programme not the start of the programme.

The “Delay Timer” function is not available for the “Spin” programme.

To set the delay timer:

- Press the “Delay Timer” button.
- Pressing the “Delay Timer” button again increases the delay by 30 minutes for each press, up to the maximum of 24 hours.

- Once the required time delay is shown on the display, the washing machine will set after approximately three seconds delay.

Extra rinse

This function adds up to 3 extra rinse cycles to the programme, which is ideal for large loads and garments belonging to people with sensitive skin. Please note: this function will increase the water consumption.

Press the “Extra Rinse” button once to select one extra rinse, the display will show “P--1”.

Press the “Extra Rinse” button again to select 2 extra rinses, the display will show “P--2”, a further press of the “Extra Rinse” button selects the maximum of 3 extra rinses with the display showing “P--3”.

The “Extra Rinse” light is illuminated and flashes during the programme, “P--1/2/3” is displayed, alternating with the remaining programme run time.

Intensive

Pressing the “Intensive” button before starting a programme selects this function. This increases the washing time during the main wash stage of the programme and is ideal for washing dirty loads.

Rinse hold

This function pauses the programme before the final rinse water is set to drain. This holds the clothes in water to prevent creasing. The indicator will flash when the rinse hold function is in progress. To start the final spin cycle, press the rinse hold button again. The indicator will switch off and the final spin programme will start.

Start / Pause

Press the “Start / Pause” button to start the selected wash programme running, the indicator light stays on. If this is pressed again while the machine is running a programme the washer will pause and the indicator light will flash.

Key lock

The lock function ensures that the programme will not be affected if any buttons are pressed accidentally.

The lock function should be activated after the wash programme has been selected together with any extra functions.

To activate the key lock, press and hold “Delay Timer” and “Extra Rinse” buttons together for three seconds.



To deactivate the key lock, press and hold “Delay Timer” and “Extra Rinse” buttons together again for three seconds.

Power cuts

- If there is a power cut, when the electricity comes back on the washing programme will continue to run from where it stopped.

Programme Listing

The table below shows the extra functions and temperatures available for each wash programme.



Index	Programme	Wash Temperature Options								Preset Spin Speed	Delay	Extra Rinse	Intense	Rinse Hold
		Cold	15	20	30	40	50	60	90					
A	Prewash **	A	A	A	A	P	A	A	A	1000	A	A	A	A
B *	Cotton	A	A	A	A	P	A	A	A	1000	A	A	A	A
C	Synthetics	A	A	A	A	P	A	A		1000	A	A	A	A
D	Wool / Handwash	P	A	A	A	A				600	A			
E	Delicate	P	A	A	A	A				600	A			
	Drum Clean								P	1000				
	Spin									1000				
	Rinse									1000	A	A		
F	Rapid	P	A	A	A					800	A	A	A	
G	Hygiene	A	A	A	A	A	A	P	A	1000	A	A	A	A
H	Mixed	A	A	A	P	A	A	A	A	1000	A	A	A	A

P – preset A – available option function  – function not available

* Programme for wash and energy consumption assessment in accordance with standard EN60456. See page 18 for detail.

Programme Details

The table below shows the details of each wash programme.

Index	Programme	Detergent Compart.	Max. Spin Load Capacity (kg)	Programme Time	Type of Laundry
A	Prewash **	1 & 2	6	2:04	Heavily soiled cotton and linens
B	Cotton	2	6	2:49	Cotton and linens
C	Synthetics	2	3	1:00	Synthetic textiles
D	Wool / Handwash	2	1	0:45	Machine washable woollens
E	Delicate	2	1	0:45	Silk, lace and other delicates
	Drum Clean	2	N/A	1:00	None
	Spin	N/A	6	0:12	Any load
	Rinse	N/A	6	0:24	Any load
F	Rapid	2	2	0:15	Lightly soiled fabrics
G	Hygiene	2	3	1:51	Sportswear and underwear
H	Mixed	2	6	1:12	Cotton, linens and synthetics

**** Note: “Prewash programme” comprises prewash, main wash, fabric conditioner (if required), rinses and final spin.**

EN60456 Testing Details

Index	Programme	Max Load (kg)	Temp. (°C)	Energy Consumption (kWh)	Water Consumption (Litre)	Washing Time	Spin Drying Performance
B	Cotton	6	60	0.808	57.7	3:00	53%
B	Cotton	3	60	0.811	45.0	3:00	-
B	Cotton	3	40	0.602	43.5	2:49	-

Energy label program settings:

1. "Cotton+ 40°C+Intense Max speed"
2. "Cotton+ 60°C+Intense Max speed"

The standard 40° and 60° cotton programmes are suitable to clean normally soiled cotton laundry and they are the most efficient programmes in terms of combined energy and water consumption. The actual water temperature may differ from the declared cycle temperature.

Note: The wash cycle times that are quoted and shown by the LED display, are intended as a guide only. Please note that factors external to the machine, e.g. the temperature of your water supply, your water pressure etc. can affect the time it takes for the wash cycle to complete.

Choice of Detergent

Programme	Detergent / Additive				
	Universal	Colour	Delicate	Special	Softener
Wool	-	-	-	L	O
Synthetic	L/P	L/P	L	-	O
Quick	L/P	L/P	-	-	O
Cotton	L/P	L/P	-	-	O
Mix	L/P	L/P	-	-	O
Delicate	-	-	L	-	O

Symbol	Detergent / Additive	Temperature Range (°C)
L	Liquid	cold - 60
P	Powder	40 - 90
O	Optional	-
-	Not applicable	-

Notes:

The delayed start option is not recommended when using liquid detergent.

Refer to the detergent manufacturer's instructions for the correct amount to use.

Remember that modern detergents wash at lower temperatures than the more traditional formulations do.

Care and Maintenance

Before beginning any care or maintenance you should always disconnect the appliance from the electricity supply, and also turn off the water supply.

If a programme has been run recently, wait for the water in the appliance to cool down to prevent risk of scalding.

Water inlet filters

There are filters on the tap side of the water inlet hose and at the end of the water inlet valve. These filters prevent ingress of dirt or foreign objects into the machine through the water supply. These filters should be cleaned approximately once a year to ensure there is no interruption in the water supply to the machine.

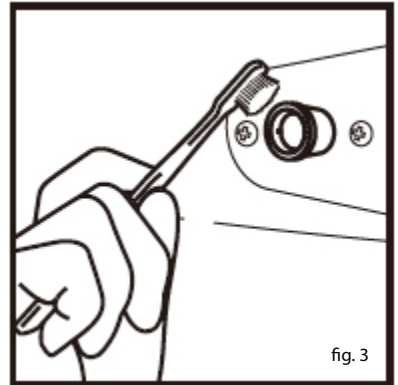

fig. 3

- Remove the water inlet hose.
- Remove the filter on the water inlet valve using pliers.
- Remove the filter on the tap end of the water inlet hose manually, as well as the seal.
- Clean the filters thoroughly using a brush.
- Replace the filters and seals carefully, in the same way as they were removed.

Pump Filter

The pump filter system prevents ingress of lint or foreign objects into the drain pump, reducing the risk of damage.

The pump filter should be cleaned regularly, every two to three months at least.

To avoid injury, do not carry out this operation when the wash water is at a temperature over 30°C

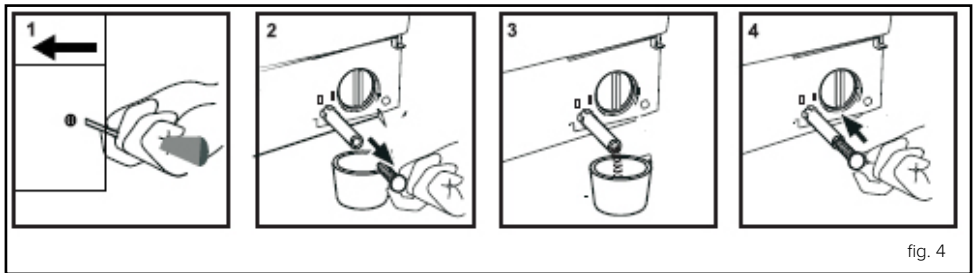

To clean the filter:

- Open the kickplate cover by undoing the single screw then sliding the cover to the left to release it from its clips.
- Release the drain hose and let it swing forward.
- Place a container under the drain hose to collect the flow of remaining water from the machine.
- Pull the bung from the end of the drain hose and let it drain. It may be necessary to reseal this hose and empty the container to prevent the container from overflowing.
- Loosen the filter cover by turning it slowly anti-clockwise until the remaining water has drained away.
- When all the water has drained out of the machine, turn the filter cover several times until the filter can be completely removed.
- Remove any objects caught in the filter and the drain pump.
- Refit the filter by turning it clockwise.
- Replace the kickplate cover by reversing the procedure above.

Please note - failure to replace the filter cover properly or to seal the drain hose will cause water to leak from the machine.

Detergent Drawer

Detergents may cause residue build up in the detergent drawer and the drawer housing over time. The drawer should be cleaned regularly to remove these residues.

To remove the drawer:

- Pull the drawer out until it stops.
- To remove the drawer, press down on the blue syphon lid inside the drawer and remove from the housing, as shown in figure 5.
- Wash the drawer and syphon lid using warm water and a brush, ensuring all compartments are clean.
- Dry the drawer thoroughly and replace the syphon lid properly.
- Remove the residues from the drawer housing without letting them fall into the machine.
- Replace the detergent drawer inside the housing, reversing the steps above.

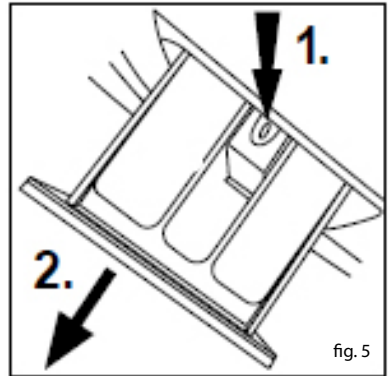

Please note - A dirty syphon will prevent the detergents from being taken in, and leave water inside the detergent drawer compartments at the end of the wash.

Cleaning the Washing Machine Exterior

The exterior of the washing machine should be cleaned with warm soapy water or a gentle cleaning agent. Do not use abrasive cleaning products or solvents.

It should then be dried thoroughly with a soft cloth.

Please note - wipe any detergent spills immediately to minimise the risk of damage to the washing machine exterior.

The Drum

Do not leave metal objects such as coins inside the drum, as these can cause the formation of rust stains.

To remove rust stains, use a chlorine free cleaner and follow the manufacturer's warnings for the cleaner.

Never use abrasive products, such as scourers, to remove rust stains.

Limescale Removal

If proprietary limescale removers are required, follow the manufacturer's warnings for the limescale remover.

Please note - Limescale removers contain acids which may affect the colour in clothes, as well as damaging the appliance.

Practical Information

Alcoholic beverages: The stain should first be washed with cold water, then wiped with glycerine and water and be rinsed with water mixed with vinegar.

Shoe Polish: The stain should be slightly scratched without ruining the cloth, rubbed with detergent and rinsed. In case it is not eliminated, it should be rubbed with 1 part of pure alcohol (96 degrees) mixed in 2 parts of water and then washed with lukewarm water.

Tea and coffee: Stretch the stained area of your cloth on the top of a container and pour through water as hot as the type of cloth can endure. If the type of cloth is suitable, wash it with lye.

Chocolate and cocoa: Soak the item in cold water and rub with soap or detergent, wash it in the highest temperature that the type of cloth can endure. If there is still a stain left, wipe with oxygenated water (in proportion of 3%).

Tomato paste: After scraping the dried pieces without ruining the cloth, leave in cold water for about 30 minutes and wash by rubbing with detergent.

Meat/soup/egg: Eliminate the dried stain residues and wipe with a sponge or soft cloth dampened with cold water. Rub with detergent and wash with diluted lye.

Grease and oil stains: First wipe the residues. Rub the stain with detergent and then wash with lukewarm soapy water.

Mustard: First apply glycerine to the stained area. Rub with detergent and then wash. If the stain still does not disappear, wipe with alcohol (On synthetic and coloured cloth, a mixture of 1 part alcohol, 2 parts water should be used).

Blood stain: Soak the item in cold water for 30 minutes. If the stain still does not disappear, soak in a mixture of water and ammonia (3 table-spoons of ammonia in 4 litres of water) for 30 minutes.

Cream, ice-cream and milk: Soak the item in cold water and rub the stained area with detergent. If the stain has still not disappeared, apply diluted lye on the fabric. (Do not use lye on coloured clothes.)

Mould: Mould stains should be cleaned as soon as possible. The stain should be washed with detergent, and if it does not disappear, it should be wiped with oxygenated water (in proportion of 3%).

Ink: Hold the stained area under cold water and wait until the inky water completely runs off. Then rub with lemon juice and detergent diluted in water, wash after waiting for 5 minutes.

Fruit: Stretch the stained area of the item on the top of a container and pour cold water on it. Do not pour hot water on the stain. Wipe with cold water and apply glycerine. Wait for 1-2 hours and rinse after wiping with a few drops of white vinegar.

Grass stain: Rub the stained part with detergent. If the type of fabric is suitable for use of lye, wash it with lye. Rub your woollen items with alcohol. (For colour, use a mixture of 1 part pure alcohol and 2 parts of water).

Oil Paint: The stain should be eliminated before it dries by applying thinner on it. Then it should be rubbed with detergent and washed.

Burnt stain: If your cloth is suitable for use of lye, you can add lye into your washing water. For woollens, a cloth damped in oxygenated water should be covered on the stain and it should be ironed with a dry cloth on it. It should be washed after rinsing well.

Display and Failure Codes

Your machine is equipped with diagnostic systems which monitor wash progress and will intervene to protect the washing machine in the event of a fault.

Failure Code	Probable failure	The process to be done
Err1	The door is not shut properly.	Shut the door properly so that you hear the click then press the "Start / Pause" button. If the error persists, unplug the machine, close the water tap and contact CDA Customer Care.
Err2	Drainage error, water not emptied within 6 minutes.	Clean the filter and check the drain hose for blockage. If the error persists, unplug the machine, close the water tap and contact CDA Customer Care.
Err3	Temperature sensor faulty or not properly connected.	Unplug the machine, close the water tap and contact CDA Customer Care.
Err4	Heater error (Appears at end of a cycle).	Unplug the machine, close the water tap and contact CDA Customer Care.
Err5	Water level not achieved in 8 minutes. Height of drain hose is below 80cm. Drain hose end is in water.	Make sure the tap is turned on and water pressure is normal. If the error persists, unplug the machine, close the water tap and contact CDA Customer Care. Install drain hose within specified range of 80-100cm. Ensure the drain hose end is not under water (to prevent syphoning).
Err7	Motor Error.	Unplug the machine, close the water tap and contact CDA Customer Care.
Err8	Water level excessive.	Unplug the machine, close the water tap and contact CDA Customer Care.
Er10	Water level sensor signal error.	Unplug the machine, close the water tap and contact CDA Customer Care.
EuAr	Communication failure between PCB and motor.	Unplug the machine, close the water tap and contact CDA Customer Care.
End	End of wash cycle.	Not a machine fault.
UNb	After last rinse cycle finishes laundry not completely balanced.	Not a machine fault.

Troubleshooting

All repairs which must be done on the machine should only be performed by authorised service agents. When a repairs is required for your machine or you are unable to eliminate the failure with the help of the information given below:

- Unplug the machine.
- Close the water tap.
- Contact CDA Customer Care.

Fault	Probable cause	Methods of elimination
The machine will not start.	It is unplugged.	Insert the plug into the socket.
	The fuse is damaged.	Replace the fuse.
	There is a fault with the power supply.	Check the power supply.
	The washer door is not properly closed.	Close the washer door.
	“Start / Pause” button has not been pressed.	Press the “Start / Pause” button.
The machine does not fill with water.	Start / Pause” button has not been pressed.	Press the “Start / Pause” button.
	Water tap is not turned on.	Turn on the water tap.
	Water pressure too low.	Check water pressure.
	The inlet hose is kinked.	Check the inlet hose.
	Water supply failure.	Check the water supply.
	Programme knob not set correctly.	Set the the programme knob correctly.
	Washer door not properly closed	Close the washer door properly.
Inlet hose filter is blocked.	Unblock the inlet hose filter.	
The machine is draining while being filled.	The height of drain hose is below 80cm.	Install drain hose at specified height of 80-100cm.
	The drain hose is in water.	Ensure the drain hose end is not immersed in water.

Fault	Probable cause	Methods of elimination
The machine does not drain water.	The drain hose is obstructed or bent.	Check the drain hose.
	The pump filter is obstructed.	Clean the pump filter.
	The drain hose is above 100cm.	Install drain hose at specified height of 80-100cm.
The machine is vibrating.	Not all transit bolts have been removed.	Remove all the transit bolts.
	The machine is located on an uneven surface or is not levelled.	Ensure the machine is located on an even surface and is correctly levelled.
	There is only a small load in the machine.	This is not indicative of a fault.
	The washing machine is overloaded, or badly loaded.	Do not exceed the load capacity, and ensure the clothes are loaded evenly.
	The washing machine is leaning on a solid object.	Ensure the machine is installed away from other objects.
The machine stops before completing its wash cycle.	Water or electricity failure.	Check the power and water supplies.
Operation stops for a period of time.	Washing machine gives an error message.	Check display codes.
	Washing machine is in a soaking cycle.	Press the "Rinse Hold" button or the "Start / Pause" button again to cancel it.
Excessive foam in the drum.	The detergent is not a low foaming type.	Check if the detergent is suitable.
	Excessive amount of detergent used.	Reduce amount of detergent used.
Washing time has changed automatically.	The washing programme duration has been changed.	This is not a fault and is a feature of the machine.
The machine fails to spin.	Unbalanced load.	Add more clothes or try running the spin cycle again.

Opening the Door in an Emergency

In the unlikely event that the machine stops mid cycle (for example during a power cut) the door may be opened manually, after first draining out the water in the drum.

To avoid injury, do not carry out this operation when the wash water is at a temperature over 30°C

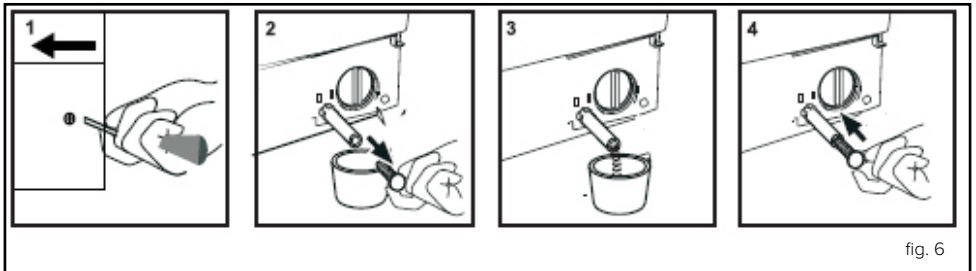

To drain the water:

- Switch off the machine then disconnect the power supply (unplug it from the socket).
- Open the kickplate cover by undoing the single screw then sliding the cover to the left to release it from its clips.
- Release the drain hose and let it swing forward.
- Place a container under the drain hose to collect the flow of remaining water from the machine.
- Pull the bung from the end of the drain hose and let it drain. It may be necessary to reseal this hose and empty the container to prevent the container from overflowing.

To open the door (after draining the water):

- You will see a plastic strap hanging down in front of the filter cover. Pulling this strap downward releases the door catch.
- Replace the kickplate cover by reversing the procedure above.

Installation

Transit bolts, located at the rear of the appliance, must be removed prior to using the appliance to prevent damage.

- Remove the back cover from the machine.
- Loosen the transit bolts (T1, T2, T3 & T4 in fig. 7) using a suitable spanner by turning them anti-clockwise and then remove them.
- Remove the plastic spacers that were retained by the transit bolts.
- Replace the back cover onto the machine.
- Cover the bolt holes with the plastic plugs supplied.

Do not throw the transit bolts or plastic spacers away. If you need to move the washing machine after installation you should first replace the transit bolts and spacers.

Do not install your machine on rugs or similar surfaces.

For your machine to work quietly and without any vibration, it should be

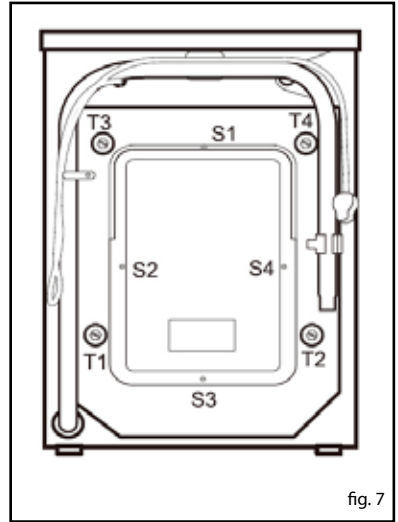

fig. 7

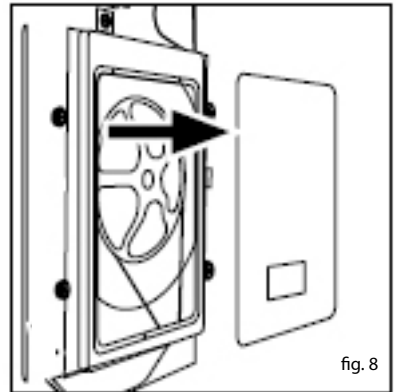

fig. 8

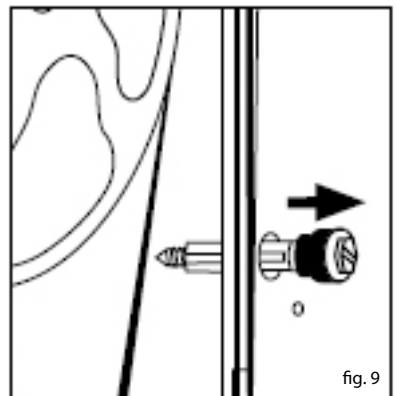

fig. 9

installed on a flat, non-slippery and solid surface.

The machine must be positioned on a solid support, such as the bare floor or a well-fitting riser, ensuring the machine is unable to fall when subjected to the typical vibrations generated by a washing machine.

Levelling

To reduce the noise from the washing machine and to prevent unnecessary movement during use, ensure the washing machine is level, using the adjustable feet.

First, fix and level the rear feet. When they are properly fixed, secure the metal locknut tightly against the underside of the washing machine.

- Put the washing machine into its required position.
- Then level the front feet in the same way as the rear feet.

Please note: Raising the washing machine too high can affect the stability of the appliance.

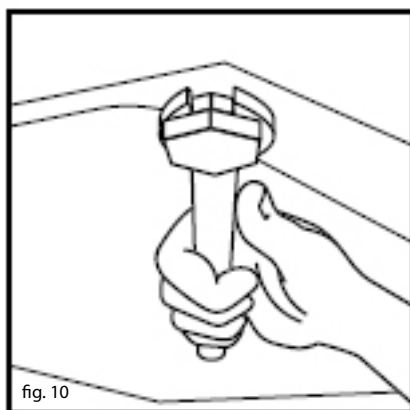

Fitting the Furniture Door

The machine is supplied with a fitting template that aligns with the top of the fascia door and has arrows cut out of it that point toward the door top.

NOTE: If this template is aligned with the top of the décor door, the resultant position will align the décor door top with the top of the machine fascia.

The required height of the door top edge above the fascia panel, and hence the gap between décor door and worktop, can only be determined by the fitter after the final height adjustment of the machine has been determined. The final positioning of the template is therefore at the discretion of the fitter.

The furniture door should be fitted to the casing of the washing machine using the hinges supplied.

Fix the magnetic catch assembly to the front of the washing machine and to the furniture door.

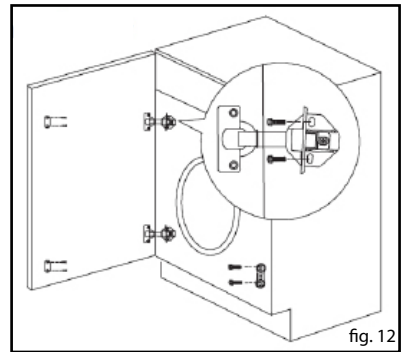
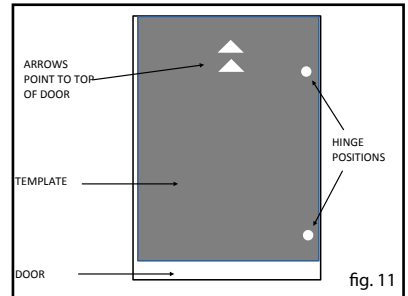

Connecting to the Mains Water Supply

- Fit the seal included in the hose packing at the end of the water inlet hose on the tap side.
- Connect the water inlet hose to a 3/4" BSP water tap. Then securely tighten the connecting nut by hand.
- After connections are completed, check there are no leaks from the connection joints by turning on your tap completely.

For your washing machine to work properly, the mains water pressure must be between 0.05 and 1MPa (0.1 - 10 bar).

Drainage Connection

- It is recommended that you have a fixed drainage outlet 80 to 100 cm from the floor.
- Avoid the drain hose being too tight, kinked or restricted.
- The water outlet can either be connected to a water drain or to a sink outlet spigot. This connection should be a minimum of 80cm and a maximum of 100cm from the floor. The drain hose should be no longer than 4m in length to ensure good performance from the washing machine.
- After connecting the water supply, check to ensure there are no leaks.

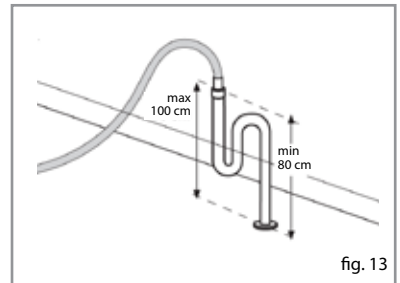

The drain hose must be securely fastened to the outlet to prevent any risk of the drain hose becoming detached and causing flooding.

Once the appliance is connected to the water supply and the drain connection, ensure that the water inlet and drain hoses are not folded, twisted, crushed or elongated by stretching when moving the appliance into position.

Electrical Information

Warning! This appliance must be earthed.

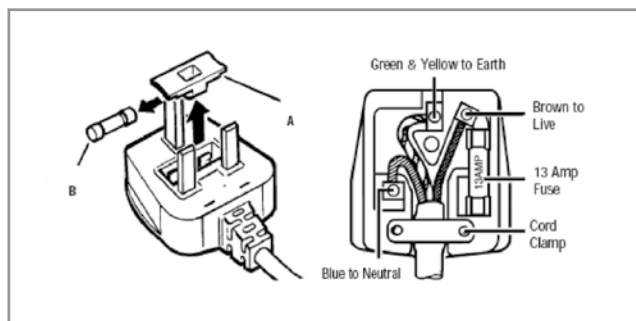

The mains lead of this appliance has been fitted with a BS 1363A 13 Amp fused plug. To change a fuse in this type of plug, follow the steps below:

1. Remove the fuse cover and fuse.
2. Fit a replacement 13A fuse, ASTA approved to BS 1362 type, into the fuse cover.
3. Replace fuse cover.

Important: Do not use the appliance without the fuse cover in position.

How to connect an alternative plug

If the fitted plug is not suitable for your socket outlet, then it should be cut off and disposed of safely to prevent the risk of electric shock. A suitable alternative plug of at least 13 Amp rating to BS 1363 should be used.

As the colours of the wires in the mains lead of this appliance may not correspond with the coloured markings identifying the terminals in your plug, proceed as follows:-

- The wire which is coloured **GREEN and YELLOW** must be connected to the terminal which is marked with the letter **(E)** or by the **Earth** symbol  or coloured **GREEN and YELLOW**.
- The wire which is coloured **BLUE** must be connected to the terminal which is marked with the letter **(N)**, or coloured **BLACK**.
- The wire which is coloured **BROWN** must be connected to the terminal which is marked with the letter **(L)** or coloured **RED**.





If in doubt regarding the electrical connection of this appliance, consult a qualified electrician. Do not shorten the supply cable, the appliance may require removing for servicing.





N.B. Ensure that the plug socket is situated in an easily accessible place.





Technical Specifications



Maximum dry laundry capacity (kg)	6
Recommended loading (kg)	See "Programme List" (page 17)
Height (cm)	82.5
Width (cm)	59,5
Depth (cm)	53.5

International Washing Symbols

			
Washing temperature	Do not wash in a washing machine	Lukewarm iron	Medium hot iron

			
Hot iron	Do not iron	Do not tumble dry	Hang to dry

			
Drip dry	Dry flat	Do not bleach	Handy to bleach

		
<p>All of these are dry cleaning symbols. The letters are to instruct the cleaner what type of solvent to be used. Garments bearing these symbols should not be washed in your machine unless the label says otherwise.</p>		



Wash up to 90 °C



Wash up to 60 °C



Wash up to 30 °C

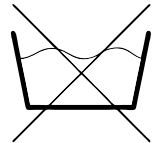

Do not wash in a washing machine

NOTES

NOTES

Energy Efficiency Information

	ci325
Rated capacity (Cotton 60° full load) (kg)	6.0
Energy efficiency class	A++
Energy consumption (kWh/annum)*	166
Water consumption (L/annum)**	11003
Spin-drying efficiency class	B
Noise (Washing) (dB(A))	57
Noise (Spinning) (dB(A))	75
Max spin speed (rpm)***	1200
Remaining moisture content (%)***	53
Energy consumption (cotton 60° full load)(kWh/cycle)	0.808
Energy consumption (cotton 60° partial load)(kWh/cycle)	0.811
Energy consumption (cotton 40° partial load)(kWh/cycle)	0.602
Water consumption (Cotton 60° full load)(L/cycle)	50
Water consumption (Cotton 60° partial load)(L/cycle)	45.0
Water consumption (Cotton 40° partial load)(L/cycle)	43.5
Power consumption (off-mode)(W)	0.48
Power consumption (left-on mode)(W)	0.48
Program duration (min) (cotton 60° full load)	180
Program duration (min) (cotton 60° partial load)	180
Program duration (min) (cotton 40° partial load)	169

•	Programme number 3 (Standard 60 ° C cotton programme) and programme number 4 (standard 40 ° C cotton programme) are the standard washing programmes to which the information on the label and the fiche relates, that these programmes are suitable to clean normally soiled cotton laundry and that they are the most efficient programmes in terms of combined energy and water consumptions.
•	The actual water temperature may differ from the declared cycle temperature.
•	Program duration, energy consumption and water consumption values may vary according to wash load weight and type, selected extra functions, tap water and ambient temperature.
*	Based on 220 standard washing cycles for cotton programmes at 60°C and 40°C at full load and partial load, and the consumption of the low-power modes. Actual energy consumption will depend on how the appliance is used.
**	Based on 220 standard washing cycles for cotton programmes at 60°C and 40°C at full load and partial load. Actual water consumption will depend on how the appliance is used.
***	Based on test results of standard 60 ° C cotton programme at full load and partial load, and standard 40 ° C cotton programme at partial load.

E & O E. All instructions, dimensions and illustrations are provided for guidance only. CDA reserve the right to change specifications without prior notice.



Please contact our **Customer Care Department** for Service on the details below

Customer Care Department

The ICDAI Group Ltd. • Harby Road • Langar • Nottinghamshire • NG13 9HY
T : 01949 862 012 F : 01949 862 003 E : customer.care@cda.eu

