

# HN6411



# Induction Hob

Installation, Use and Maintenance

**IMPORTANT:** PLEASE REFER TO PAGE 20 FOR INFORMATION ON CONFIGURING THE POWER CONSUMPTION MODE CORRECTLY. THE HOB MUST BE CONFIGURED AT FIRST SWITCH ON.

# Important

The CDA Group Ltd cannot be held responsible for injuries or losses caused by incorrect use or installation of this product. Please note that CDA reserve the right to invalidate the guarantee supplied with this product following incorrect installation or misuse of the appliance or use in a commercial environment.

This appliance is not designed to be used by people (including children) with reduced physical, sensorial or mental capacity, or who lack experience or knowledge about it, unless they have had supervision or instructions on how to use the appliance by someone who is responsible for their safety.

Under no circumstances should any external covers be removed for servicing or maintenance except by suitably qualified personnel.

## Appliance information:

Please enter the details on the appliance rating plate below for reference, to assist CDA Customer Care in the event of a fault with your appliance and to register your appliance for guarantee purposes.

Appliance Model	
Serial Number	

## EU Declarations of Conformity

This appliance has been manufactured to the strictest standards and complies with all applicable legislation, including Electrical safety (LVD) 2014/35/EU and Electromagnetic interference compatibility (EMC)

2014/30/EU. Parts intended to come into contact with food conform to 1935/2004/EC.

## **IMPORTANT INFORMATION FOR CORRECT DISPOSAL OF THE PRODUCT IN ACCORDANCE WITH EC DIRECTIVE 2012/19/EU.**

At the end of its working life, the product must be taken to a special local authority waste collection centre or to a dealer providing appliance recycling services.

Disposing of a household appliance separately avoids possible negative consequences for the environment and health. It also enables the constituent materials to be recovered, saving both energy and resources. As a reminder of the need to dispose of household appliances separately, the product is marked with a crossed-out wheeled dustbin. 

### **Please note:**

- Induction hobs become hot and remain hot during and immediately after use. Do not touch the hob until it has been allowed to cool.
- Keep children away from the appliance when in use.
- Never use the hob top for storage.
- Pan handles should never stand out beyond the edge of the worktop. This will ensure children cannot reach them.
- Do not lean over the hob when it is in use.
- Follow the cleaning instructions carefully.
- Ensure the base of the saucepan is clean and dry before placing it on the hob.
- Avoid hard shocks from cookware – the vitroceramic glass surface is highly resistant but not unbreakable.

- Do not place hot lids flat on the hob top. A “suction” effect could cause damage to the hob.
- Do not drag cookware across the hob top: in the long term, this could cause damage to the hob.
- Do not store cleaning or flammable products in the unit below the hob.
- Always use appropriate cookware.
- Do not cook unopened tins of food directly on the hob.
- Never put cooking foil or plastic materials on the ceramic surface when the hob is hot. These materials could melt and cause damage to the hob.
- This hob (Class 3) has been designed for use only as a cooking appliance. Any other use should be considered incorrect and therefore dangerous.

**FOR THOSE WITH HEART PACEMAKERS OR ACTIVE IMPLANTS:**

The function of this hob conforms to current electromagnetic interference standards and thus is in total compliance with legal requirements (2004/108/CE directives).

To avoid interference between your hob and a pacemaker, your pacemaker must be designed and programmed in compliance with the regulations that apply to it. As such, CDA guarantee only that our product is compliant.

With regard to the compliance of the pacemaker or any potential incompatibility, you should obtain information from the manufacturer or your attending physician.

---

## Important

- Do not use the hob if the glass surface is cracked or damaged to prevent the risk of electric shock. Disconnect it from the power supply.
- Ensure that the power cables of connected electrical appliances near the hob are not in contact with the cooking zones.

**Important: Please refer to page 20 for information on configuring the power consumption mode correctly. The hob must be configured at first switch on.**

# Cooking on induction

The principle of induction cooking is based on magnetic effect.

When you put your cookware on an induction zone and switch it on, the electronic boards in the hob produce induced currents in the base of the cookware and instantly raise its temperature. This heat is then transferred to the food inside the cookware.

The best cookware to use with induction cooking has thick flat bases, as the heat will be better distributed so cooking more evenly.

Most cookware is compatible with induction cooking. There are three ways to check the suitability of your cookware:

1. Use a magnet to see if the base of the pan is magnetic: if the magnet sticks, then the cookware is compatible.
2. Place the pan on one of the cooking zones switched on to power level 4: If the display remains on, then the cookware is compatible. If the display flashes, the cookware cannot be used on an induction hob.
3. Check the instructions or packaging of the pans for the symbols indicating suitability for use with induction.

# Control panel

## Zones:

1. Front left 1.5 kW (2.0kW boost) 210 mm
2. Back left 1.2 kW (1.6kW boost) 145 mm
3. Back right 1.5 kW (2.0kW boost) 210 mm
4. Front right 1.2 kW (1.6kW boost) 145 mm

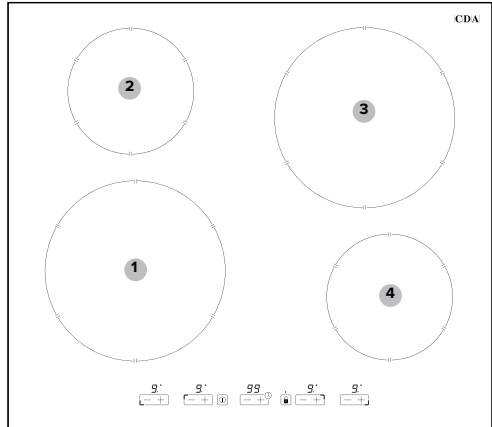

## Control panel:

5. Power key
6. Timer keys
7. Safety key lock sensor
8. Zone power level keys
9. Zone displays

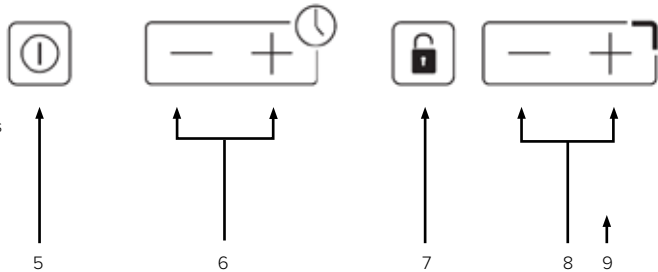



Fig.1

The table below offers guidance as to what each power level is for.

Power level	Type of cooking
0	Switched off
1/2	Melting (butter/chocolate) or keeping food warm
2/3	Keeping food hot or to heat small quantities of liquid
3/4	Heat larger quantities of liquid (sauces etc.)
4/5	Slow boiling, e.g spaghetti, soups, stews, potatoes
6/7	Gentle frying
7/8	Browning meats, frying fish, omelettes
9	Fast frying steaks

# Using your hob

## To switch the hob on

To switch the power on, touch and hold the  key for approximately two seconds. The hob will beep and all four zone displays will show zero.

**Please note: If a power level is not set within ten seconds, the hob will switch off automatically.**

## To set the power level

There are power keys for each individual zone which allow you to set the power level by touching the “+” or “-” keys for the zone required.

To increase the power level from 1 (minimum) toward 9 (maximum), touch the “+” key.

To go straight to power level 9, touch the “-” key when the zone display shows “0”.

## To turn the power off

To switch off a single zone, touch the “+” and “-” keys together for the zone no longer required. This will set the power level to zero. Alternatively, touch the “-” key until the zone display shows zero. When all the zones are at zero, the hob will switch off automatically after approximately ten seconds.

Alternatively, to switch off the hob immediately, touch and hold the  key for approximately two seconds.



## Booster

The hob is equipped with a booster function, allowing a higher power level than the maximum for approximately ten minutes. To turn on the booster function, touch the “+” key when the power level is already set at 9. “**P**” will show in the display. To cancel the booster at any time, touch the “-” key to return to power level 9.

## Timer

The hob is equipped with a timer that allows a finish time to be set for the end of cooking on any zone, between a minimum of one minute and a maximum of 99 minutes. This timer can be used only one zone at a time.

### To set the timer

First switch on the hob.

Touch either the timer “+” or “-” keys. The timer display will show “**00**” and the zone displays will flash “**t**”.

Set the power level for the zone requiring the timer by touching the “+” or “-” key for the required zone. The timer indicator LED will illuminate on the zone to confirm the timer is selected.

Set the required duration using the timer “+” or “-” keys within five seconds. Touching the timer “-” key will go straight to the maximum 99 minutes. Touch and hold the timer “+” or “-” keys to scroll through the duration quickly.

After approximately five seconds, the LED and the timer display will stop flashing and the countdown will start. The timer display will show the minutes remaining until the last minute, when it will show the seconds remaining.

---

At the end of the timer, the selected zone will switch off and the timer display and the zone timer LED will flash. The hob will beep for approximately one minute. To switch off the beep and the flashing displays, touch any key.

### **To cancel the timer**

Touch the timer “+” and “-” keys together.

**Please note: Cancelling the timer will not switch off the zone. You should switch the zone off manually if required.**

**Please note: the power level can be adjusted during the countdown using the “+” or “-” keys.**

## **Safety key lock**

The hob is equipped with a safety key lock to lock the controls. This can be used when the hob is off or during cooking.

### **To switch on the safety key lock**

Touch the  key for approximately two seconds until the LED above the safety key lock sensor illuminates and the hob beeps to confirm the safety key lock is switched on.

### **To turn off the childlock**

Touch the  key for approximately two seconds until the LED above the safety key lock sensor switches off and the hob beeps to confirm the safety key lock is switched off.

## Use of the safety key lock when the hob is off

The safety key lock LED is illuminated to show the childlock is on.

## Use of the safety key lock when the hob is in use

The safety key lock LED is illuminated to confirm that the lock is switched on and no adjustments can be made to any of the zones or the timer. It is possible to switch off the hob using the  key when the lock is on for safety reasons.

### Please note:

The safety key lock is switched on automatically when the hob is first connected to the power. You must switch off the lock to be able to configure and use the hob.

## Residual heat indicators

The hob is equipped with residual heat indicators to warn when any of the zones are still hot to the touch after cooking. An “**H**” will show in the relevant zone display after cooking until the zone is at a safe temperature to touch.

In the event of a power cut, the residual heat indicators will illuminate after the power supply is restored. However, when there is no power supply to the hob the residual heat indicators will not work, so extra care must be taken.

### Please note:

You should avoid touching the zones when the hob is in use, or when an “**H**” is showing on the zone display.

---

## Small object safety

Anything left on the control panel (e.g. cutlery or towels) will cause the hob to switch off automatically and there will be a beep every ten seconds until the obstruction is removed.

## Temperature limiter

The hob is equipped with a temperature limiting sensor that will switch off the zone and show “**C**” alternating with the power level in the zone display until the hob temperature is within the limits preset.

## Pan detection

The hob is equipped with a sensor that will advise when the pan is removed from the zone, or is unsuitable for use on induction hobs. The zone display will show “**U**” alternating with the power level until a suitable pan is placed on the zone. The zone will switch off after approximately one minute if no suitable pan is placed on the zone.

# Efficient Use of Your Hob

The hob is equipped with zones of different sizes, designed to accommodate most shapes and sizes of pan. For best results, only use pans with flat bottoms and choose an appropriate zone depending on the size of the pan. The most efficient use of the hob is shown below, where the pan and zone are correctly chosen.

Use pan lids where possible to minimize the energy usage of your appliance.

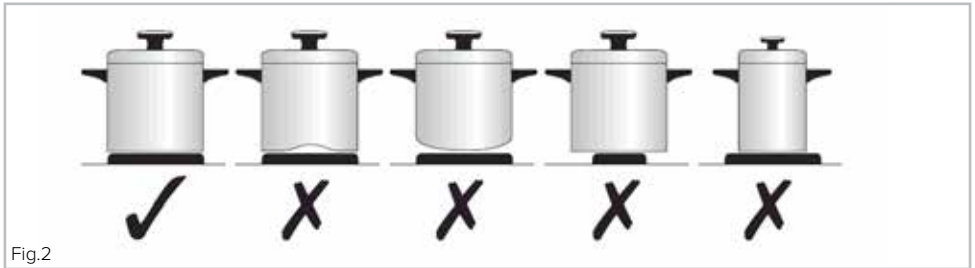

Fig.2

Zone Size	Minimum Pan Size (cm)	Maximum Pan Size (cm)
160mm	10	18
180mm	12	22
210mm	18	24

It is very important that the pans used on the hob are made of a suitable material and have the correct type of base. The base of the pan must be clean before use to prevent any scratches on the hob top.

# Care and Maintenance

Always disconnect the appliance from the power supply before undertaking any cleaning or maintenance.

## Important:

- Steam cleaners must not be used when cleaning this appliance. You should use a non-abrasive cleaner to clean the hob top. Any abrasive cleaner (including Cif) will scratch the surface and could erase the control panel markings.
- Sugar and starch can cause permanent damage to the surface of the hob. Wipe away any spillages immediately.

Types of residues	Clean with	Cleaning advice
Light	Cleaning sponge and soft cloth	Wipe over the zone to be cleaned with a sponge and hot water, and then wipe off with a soft dry cloth.
Accumulated baked-on stains/dirt, sugar spills or melted plastics	Cleaning sponge or glass scraper and soft cloth	Wipe over the zone to be cleaned with a sponge and hot water, using a ceramic scraper to remove any large marks or stains and then wipe off with a soft dry cloth.
Rings and hard water residues	White vinegar and soft cloth	Pour a small amount of warm white vinegar onto the stain, leave it to stand, and then wipe off with a soft dry cloth.
Shiny metallic streaks	Cleaning agent for vitroc ceramic glass etc.) Slow boiling, e.g. spaghetti, soups, stews, potatoes	Use specialist vitroc ceramic glass cleaner (preferably one with silicone for its protective properties)

## If your hob is not working:

1. Check that the zone is switched on.
2. Check that the mains supply has not been switched off.
3. Check that the fuse in the spur has not blown.
4. Check the hob is configured correctly (see page 20).

In the event of a fault with the hob, please advise CDA Customer Care of any fault code shown on the display.

## Contact CDA Customer Care

**A** : Customer Care Department, The CDA Group Ltd, Harby Road, Langar, Nottinghamshire, NG13 9HY

**T** : 01949 862 012 **F** : 01949 862 003

**E** : customer.care@cda.eu **W** : www.cda.eu

# Troubleshooting

## On first use

You observe that	Possible Causes	What should you do?
The display shows a series of digits and symbols on first connection	Working normally	Nothing, the hob will be ready to use within approximately 10 seconds
Installation blows a fuse or only one side of the hob works	The electrical connection of the hob is incorrect	Check that it is set up properly (see the Electrical Connection section)
The hob produces an odour during the first cooking sessions	New appliance	Heat a saucepan full of water on each cooking zone for 30 minutes

## On switching on

You observe that	Possible Causes	What should you do?
The hob does not work and the lights on the control panel do not switch on	The hob is not connected to the power supply or the power supply is faulty	Check the electrical circuit breaker and fuses
The hob is not working and the display shows a non-standard graphic	The electronics are not functioning correctly	Call CDA Customer Care
The hob is not working and the safety key lock LED is on	The safety key lock is on	Switch off the lock before trying to use the hob.

## In use

You observe that	Possible Causes	What should you do?
The hob has stopped operating. The hob beeps at approximately ten second intervals	There was an overflow or an object is in contact with the control panel	Clean the hob or remove the object, and begin cooking again
C shows on the zone display	The temperature limiter sensor has been activated	Allow the zone time to cool down.
U flashes on the zone display	The cookware used is not suitable for induction or is less than 12 cm in diameter (10 cm on the 16 cm zone)	See page 6 for information on cooking on induction
The saucepans make noise during cooking or your hob makes a clicking sound during cooking	This is normal with some types of cookware. This is caused by the transfer of energy from the hob to the cookware	Nothing. There is no risk, neither to your hob nor to your cookware
The fan continues to function for a few minutes after the hob is turned off	Cooling of the electronic components. Working normally	Nothing.
The hob keeps blowing the mains fuse	This is most likely to be caused by an incorrect power configuration setting	Refer to the instructions on configuring your hob (page 20)

**IMPORTANT - PLEASE NOTE:** In the event of any breakage, crack or cracking – even minimal – of the vitroceramic glass, immediately disconnect your appliance to prevent a risk of electric shock and contact CDA Customer Care. Contact details can be found on page 15 of this manual.



# Fitting the Hob

## **Unpacking the hob:**

Take care not to lose or mishandle any parts.

## **Fitting position of the hob:**

This appliance must be installed a minimum of 50mm from any back wall and a minimum of 180mm away from any adjacent vertical surfaces, e.g. a tall cupboard end panel. This may be reduced to 100mm if the adjacent surface is resistant to fire (tiles or steel, for example). These dimensions are shown in Fig. 5.

## **Ventilation requirements:**

This appliance must be installed to allow air to flow freely to the air intake, from the air outlet and in the base and run of units into which it is installed (Fig 3). Failure to allow sufficient ventilation could cause damage to the hob and constitutes incorrect installation, which is not covered by the warranty.

## **Notes:**

- This could be a simple slot cut out of the plinth, or a dedicated ventilation grille.
- The furniture top rail should not be fitted to the unit. This allows the induction hob to exhaust air into the kitchen space.
- The recommended ventilation sizes are for guidance only.

## **If fitting a cooker hood above the hob:**

If a cooker hood is to be installed above the hob, the height of the hood above the hob must be at least 600mm (650mm is

recommended) (Fig. 4). If the instructions supplied with the hood dictate that the hood must be installed at a height greater than 600mm, then that height is the minimum required.

### **Wall furniture requirements:**

The minimum height of any cabinet immediately above the hob is 900mm. The minimum height of any adjacent units (including light pelmets) is 400mm, unless they are manufactured from a material resistant to fire (steel, for example).

### **Notes:**

- Do not position this appliance above a refrigeration unit. The heat generated may cause the refrigeration unit to fail.
- This appliance is designed to be installed into cabinet units capable of withstanding temperatures of 65°C or greater above ambient temperature.
- Never place perishable foods, soft items such as tea towels, cleaning products or flammable items in the cupboard or drawer below the appliance.
- If an oven is to be installed below the hob, the thermal safety system on the hob will not allow the hob to be used at the same time as a pyrolytic programme on the oven.
- The hob is equipped with an anti-overheating safety device that can be activated if the hob is installed over an oven that is not sufficiently ventilated. In the event that this occurs, the zone display will show “**C**”. We recommend that you increase the ventilation of the hob by creating an opening in the side of the cabinet (8cm x 5cm).

# How to Install the Hob

## Overall dimensions of the hob:

Width: 580 mm Depth: 510 mm

## Worktop cut-out dimensions:

Width: 560 mm Depth: 490 mm

1. Make the required hole in the worktop. Before doing this, you must check the instructions supplied with any cooker hood to ensure that you will have the required clearance. The cut-out (Fig. 5) shows a 60mm gap from the wall to the cut-out edge. The distance from the hob, when fitted, to the back wall is 50mm.

If a splashback/worktop upstand is to be fitted, take this into account when cutting the hole. The minimum distance that the hob should be positioned away from the rear wall or splashback is 50mm.

2. Fix the foam seal underneath the appliance by following the outline of the worktop upon which the hob will rest. This ensures an airtight seal with the worktop. Do not use silicone type sealant.

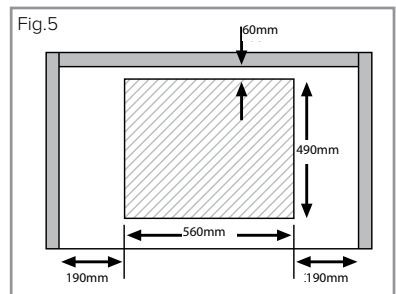
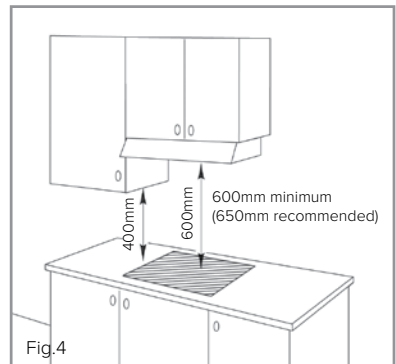
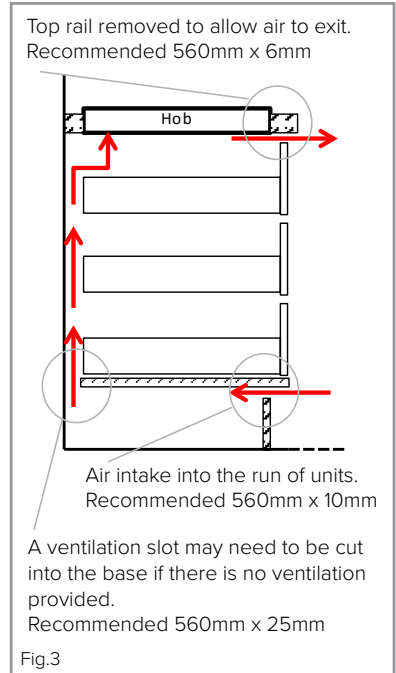

# Power Configuration

This hob can be connected to a 13, 16, 25 or 32Amp supply and configured to work on any of these power settings.

If the hob is connected to a 32Amp supply all four zones can be used on the maximum setting with boost at the same time. If, however, the hob is connected and configured to a 13Amp supply and all four zones are selected at the same time the hob will limit the maximum power consumed so that the 2.8kW power supply cannot be exceeded.

## To configure the hob at first switch on

1. Switch on the power supply.
2. All the displays will show **“8”** briefly then just the safety key lock symbol will show.
3. Touch the  key to switch off the lock.
4. Touch the “+” and “-” keys for the front left zone and the “+” and “-” keys for the front right zone, all simultaneously.
5. Touch the front left zone “-” key to cycle through the options.

The displays will show:

Front left zone display	Timer display	Front right zone display	Power Settings
2	PO	8	2.8 kW
3	PO	5	3.5 kW
6	PO	0	6.0 kW
7	PO	2	7.2 kW

6. Touch the “+” and “-” keys for the front left zone and the “+” and “-” keys for the front right zone, all simultaneously, to confirm the setting.

All displays will show “**8**” and then switch off. The childlock will be switched back on automatically, and the hob is now configured ready for use.

**NOTE:**

- On first use the power setting is factory set to 7.2kW.
- In the event of power supply interruption, the hob will remember the previous configuration setting when the power supply is restored.

**To change the configuration setting**

1. Switch off the power supply to the hob at the dedicated cooker outlet (or switched fused spur for 2.8kW setting only).
2. Leave the power supply switched off for at least five minutes.
3. Switch on the power supply again.
4. All the displays will show “**8**” briefly then just the childlock symbol will show.
5. Follow the instructions under “To configure the hob at first switch on” (opposite) from number “3” onward.

# Mains Electricity Connection

## Warning! this appliance must be earthed

We recommend that the appliance is connected by a qualified electrician, who is a member of the N.I.C.E.I.C. and who will comply with the I.E.T. and local regulations.

This hob is intended to be connected to permanent, fixing wiring and dependent on the power configuration is intended to be connected to a 13A supply or connected via a 13A plug. The table below shows the recommended size of cable and the fuse that will be required for each power configuration mode.

Power configuration mode	Mains cable size (CSA, mm <sup>2</sup> )	Fuse protection required
2.8kW	1.5	13
3.5kW	1.5	16
6.0kW	2.5 - 4.0	25
7.2kW	2.5 - 4.0	32

The following diagram shows the main connection terminal block:

### Terminal connections:

1 & 2: Live (linked)

4: Neutral

⊥: Earth

### 2.8kW mode

When the hob is configured in 2.8kW mode it can be connected via a standard 13A switched fused spur.

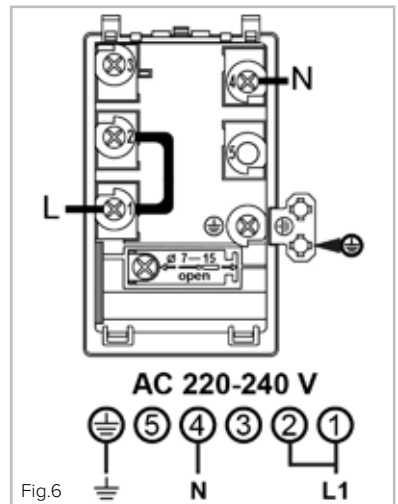

### **3.5kW-7.2kW modes**

When configured in any mode other than the 2.8kW, the hob should be installed into a dedicated cooker outlet and protected by the size of fuse shown in the table above.

This appliance is intended to be connected to fixed wiring by a double pole switch, having a contact separation of at least 3mm in all poles. The switch must be positioned no further than 2m from the appliance.

#### **Please note:**

The mains cable must only be replaced by a qualified electrician or service engineer and be of a cross sectional area appropriate for the power configuration mode of the hob, as shown in the table above.

The marking of the current rating of the fuse or circuit breaker protecting this appliance should be marked on the socket outlet. Assembly and electrical connection should be carried out by specialised personnel.

When installing this product we recommend you seek the help of another individual.

Ensure that the brass links are securely fitted. Failure to do so will prevent the hob from operating correctly.

**Any service call arising from incorrect installation may result in a charge.**

E & O E. All instructions, dimensions and illustrations are provided for guidance only. CDA reserve the right to change specifications without prior notice.

---

**NOTES:**



---

**NOTES:**

---

**NOTES:**

## Energy Efficiency Information

Attribute	Symbol	Value	Units
CDA model		HN6411FR	
Type of hob		Built in	
Number of cooking zones and/or areas		4	
Heating technology (induction cooking zones and cooking areas, radiant cooking zones, solid plates)		Induction cooking zones	
For circular cooking zones or area: diameter of useful surface area per electric heated cooking zone, rounded to the nearest 5mm	∅	FL:21.0/ FR:15.0/ RL:15.0/ RR:21.0	cm
For non-circular cooking zones or areas: length and width of useful surface area per electric heated cooking zone or area, rounded to the nearest 5mm	L W	NA	cm
Energy consumption per cooking zone or area calculated per kg	EC <small>Electric cooking</small>	FL:179.9/ FR:174.8/ RL:198.0/ RR:180.0	Wh/kg
Energy consumption for the hob calculated per kg	EC <small>Electric hob</small>	183.2	Wh/kg



Please contact our **Customer Care Department** for Service on the details below

**Customer Care Department**

The ICDAI Group Ltd. • Harby Road • Langar • Nottinghamshire • NG13 9HY  
T : 01949 862 012 F : 01949 862 003 E : customer.care@cda.eu

