



# WC371

# Integrated Intelligent Dishwasher

Installation, Use and Maintenance

---

# Contents

- 3 Important information
- 5 Important notes
- 6 Before first use
- 7 Using your dishwasher
- 10 Starting a programme
- 10 Changing a programme
- 11 Cancelling a programme
- 12 Detergent information
- 13 Salt information
- 14 Softener adjustment
- 16 Rinse aid information
- 17 Dishwasher basket information
- 19 Standard loading
- 21 Programme listing
- 23 Care and Maintenance
- 25 Fault code information
- 26 Troubleshooting
- 27 Electrical Information
- 29 Installation
- 33 Installation - final checks

# Important

The CDA Group Ltd cannot be held responsible for injuries or losses caused by incorrect use or installation of this product. Please note that CDA reserve the right to invalidate the guarantee supplied with this product following incorrect installation or misuse of the appliance.

This appliance is not designed to be used by people (including children) with reduced physical, sensorial or mental capacity, or who lack experience or knowledge about it, unless they have had supervision or instructions on how to use the appliance by someone who is responsible for their safety.

Under no circumstances should any external covers be removed for servicing or maintenance except by suitably qualified personnel.

## **Appliance information:**

Please enter the details on the appliance rating plate below for reference, to assist CDA Customer Care in the event of a fault with your appliance and to register your appliance for guarantee purposes.

Appliance Model	
-----------------	--

Serial Number	
---------------	--

This appliance has been designed for domestic use only. Commercial use will invalidate the warranty.

---

## **EU Declarations of Conformity:**


This product meets the requirements of all applicable EU directives with the corresponding harmonised standards, which provide for CE marking.

## **Availability of this manual in an alternative format:**

A soft copy of this manual is available for download from [www.cda.eu](http://www.cda.eu).

## **IMPORTANT INFORMATION FOR CORRECT DISPOSAL OF THE PRODUCT IN ACCORDANCE WITH EC DIRECTIVE 2012/19/EU.**

At the end of its working life, the product must be taken to a special local authority waste collection centre or to a dealer providing appliance recycling services.

Disposing of a household appliance separately avoids possible negative consequences for the environment and health. It also enables the constituent materials to be recovered, saving both energy and resources. As a reminder of the need to dispose of household appliances separately, the product is marked with a crossed-out wheeled dustbin .

## Important

- Read the instructions prior to installation and use of the appliance.
- Do not lean or climb on the open dishwasher door, to prevent damage.
- Close the dishwasher door after use to prevent accidents.
- Use only detergents, salt and rinse aid specifically designed for dishwashers.
- Do not put solvents in the dishwasher detergent compartment to prevent risk of explosion.
- Only put dishwasher safe items into the dishwasher. If in doubt, check with the manufacturer of the items.
- Take care when loading the dishwasher to observe the recommendations for best loading practice, and also to ensure that sharp objects such as knives are placed blade down to prevent accidents.
- Do not open the dishwasher door when a programme is running. If it is necessary to do so, then open it only slightly to allow the dishwasher to pause the programme and prevent any water spilling out. Remember that the water in the dishwasher can be very hot when the programme is running.
- When the dishwasher is not in use, we recommend that you turn off the water supply at the supply tap and disconnect the main supply.
- If you are leaving the dishwasher for an extended period you should leave the door slightly open to prevent the formation of unpleasant smells.

- This appliance can be used by children aged from 8 years and above and persons with reduced physical, sensory or mental capabilities or lack of experience and knowledge if they have been given supervision or instruction concerning use of the appliance in a safe way and understand the hazards involved. Children shall not play with the appliance. Cleaning and user maintenance shall not be made by children without supervision.
- The plastic housing on the water inlet pipe contains an electrically operated valve. The wires that connect to this valve are inside the inlet hose. Do not cut through the inlet hose and do not put the plastic housing in water.
- Children could get locked inside the appliance. Therefore, when disposing of an old appliance cut off the plug and set aside. Damage the door lock so that the door can no longer be closed.

## Recommendations

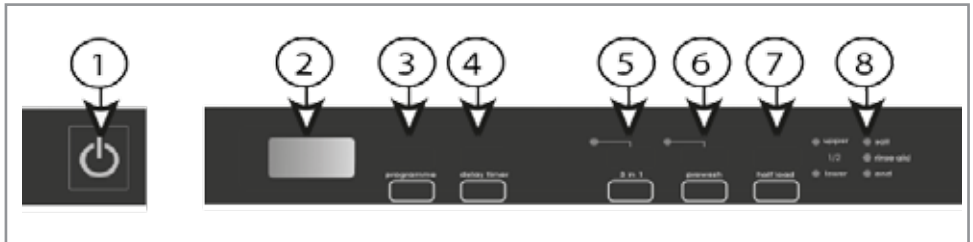
- To reduce energy and water consumption, remove all dirt residues from the dishes prior to loading the dishwasher.
- Only run the dishwasher when fully loaded, unless half-load is active.
- Place hollow items (bowls, glasses and pans) face down in the basket.

## Before first use

- Set the water softener level as required by the water hardness in the area (see pages 14-15).
- Add 1kg of salt into the salt compartment and then fill with water to the top of the salt compartment.

- Remove all the packaging materials from the interior of the dishwasher.
- Fill the rinse aid compartment.
- Run a hot programme without any dishes in the dishwasher.

## Control panel



### Power button (1)

- To switch the dishwasher on or off, press the power button (1).  
When you switch on the dishwasher, the end of programme light will illuminate, and two dashes will appear on the display.

### Programme display (2)

The programme display shows the selected programme and the remaining time to run. If there is a fault on the dishwasher, the fault code will show on the display.

### Programme selection button (3)

- To select a programme, press the programme selection button (3).  
The dishwasher will store in its memory the last programme used.

### **Delay timer button (4)**

The dishwasher is equipped with a variable timer of up to 19 hours' duration at hourly intervals.

- To set the delay timer, press the delay timer button (4). This will switch the timer on for one hour.
- To change the delay duration, press the delay timer button again until the required delay duration is shown on the display, alternating with the selected programme and the programme duration.
- To cancel the delay timer, press the delay timer button again until 0h shows on the display.

### **3 in 1 function button (5)**

The dishwasher is equipped with a tablet function that automatically adjusts the amount of rinse aid and dishwasher salt used during a programme.

- To use this function, press the button after selecting the programme, before you close the door.

### **Prewash button (6)**

The dishwasher is equipped with a prewash function that automatically adds a prewash to the selected programme.

The prewash function improves the wash performance of the programme, but also can change the temperature and duration of the programme.

- To use this function, press the button after selecting the programme and before you close the door.



The prewash is also an independent programme (8) which can be used to rinse the contents of the dishwasher, for example if the dishwasher is not yet full and a complete programme is not yet required.

- To use this function, select the programme as described on page 10.

### **Half-load button (7) and indicator lights**

The dishwasher is equipped with a half-load function that allows for either the upper or lower basket to be washed independently, or for both baskets to be washed if they contain only a small number of dishes.

### **Salt and rinse aid warning lights (8)**

When the dishwasher salt or rinse aid begins to run out, the warning light will illuminate to advise that it needs refilling.

### **End of programme light (8)**

When the programme is complete, the dishwasher will emit five beeps and the end of programme indicator light will illuminate.

**Please note: You should ensure that there are no dishes in the upper basket when running a lower basket half-load programme, and none in the lower basket when running an upper basket half-load programme.**

**If you have selected any extra function (3 in 1, prewash, half-load) for a programme, this function will automatically be selected the next time the dishwasher is used. To cancel the selection of any**

**extra function, press the specific extra function button (5, 6 or 7) until the indicator light for that function goes out.**

### **Starting a programme**

- Press the Power button (the end of programme light will be switched on)
- Press the Programme Selection button until the required programme is shown on the display.
- If required, set the delay timer by pressing the Delay Timer button
- Once a programme is selected, the end of programme light will switch off.
- When you close the dishwasher door, the programme will start automatically.

**Please note: The dishwasher stores the most recently used programme in its memory. To change the programme, simply press the Programme Selection button.**

### **At the end of a programme**

If possible, do not open the dishwasher door once the programme has started.

At the end of a programme, the dishwasher will beep five times, and the end of Programme Indicator light will switch on.

### **Changing a programme**

It is possible to change the programme if necessary once the programme has started.

- First open the door slightly to reduce the risk of water spillage.
- Press the programme selection button until the required

programme is shown on the display.

- Then close the door. The dishwasher will begin the new programme from the point at which the old programme stopped.

### **Cancelling a programme**

It is possible to cancel the programme once it has started.

- First open the door slightly to reduce the risk of water spillage.
- Press and hold in the Programme Selection button for three seconds until the end of programme indicator flashes and a “1” shows on the display.
- Then close the door. The dishwasher will run a drain cycle which will take approximately 30 seconds. Once this is complete, the dishwasher will beep five times and the end of programme light will switch on.

### **Switching the dishwasher off**

- Once the dishwasher beeps five times and the end of programme light switches on, the dishwasher can be switched off by pressing the Power button.
- Then turn off the water tap and remove the plug from the power socket.

**Please note: The dishwasher will automatically continue on the programme it has started if the door is opened or in the event of a power cut and once power has been restored or the door closed.**

# Detergent

## To fill the detergent compartment

1. Push the latch to open the compartment.
2. Add the required amount of detergent. The main detergent compartment (b in Fig. 1) has lines to allow for specific amounts of detergent.

These are marked at either 15cm<sup>3</sup> or 25cm<sup>3</sup>, depending on how dirty the dishes are.

If your dishes are in need of an intensive wash, then add 5cm<sup>3</sup> of detergent into the prewash section of the compartment (a in Fig 1).

3. Then close the detergent compartment lid until the latch locks.

**Please note: You should only use detergents designed specifically for use in dishwashers.**

If using dishwasher tablets, always use the detergent compartment, do not put them in the main body of the dishwasher or in the cutlery basket. The solubility of dishwasher tablets can vary depending on the temperature and duration of the programme. As a result, it is recommended that powder detergents should be used in the shorter programmes to allow better performance.



Fig. 1



Fig. 2



Fig. 3

CDA recommends the use of separate detergent, rinse aid and dishwasher salt, rather than combination tablets, as separates achieve better wash performance.

If you do use combination detergents, add salt and rinse aid to the dishwasher and then adjust the water hardness setting and rinse aid setting to the minimum. When you then use separate detergents again, you should fill the salt and rinse aid compartments, adjust the water hardness setting to the maximum and run an empty wash, then adjust the water hardness setting and the rinse aid setting to the appropriate level.

## Salt

To ensure the best efficiency, the dishwasher needs soft water. Hard water means that lime residues remain on the dishes and the interior of the dishwasher, affecting performance. The softener system is designed to remove the ions that make the water hard to provide the best quality wash performance. This is achieved by using dishwasher salt.

### **To add dishwasher salt**

1. Remove the lower dishwasher basket and then unscrew the salt compartment cap, as shown in Fig. 2 (page 12).
2. Fill the compartment with dishwasher salt (do not use table salt), carefully to prevent unnecessary spillage. Before first use, you should fill the compartment with 1kg of dishwasher salt and then fill up the salt compartment with water (up to the brim of the compartment) as shown in Fig. 3 (page 12).

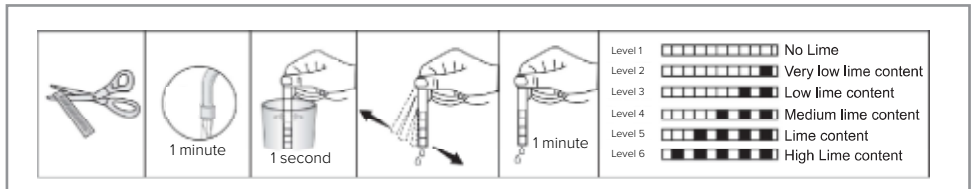
3. Replace the cap and the lower basket.

When the 'Salt Warning' light on the control panel illuminates, you should refill the salt compartment with salt only – do not add water to the salt compartment after the first use.

**You should run a programme immediately after adding dishwasher salt, to prevent any damage to the dishwasher systems.**

## Softener adjustment

The efficiency of your dishwasher depends on the softness of the tap water. To ensure best efficiency, the dishwasher is equipped with a system that reduces the hardness in the mains water supply. The efficiency will increase when the system is correctly set. To find out the water hardness level of your water supply you can use the test strip supplied or alternatively contact your local water board.



1. Open the testing strip.
2. Run water through the tap for one minute.
3. Hold the testing strip in water for one second.
4. Shake the testing strip after taking it out of the water.
5. Wait for one minute.
6. Check the number of marks on the strip to see the level of water hardness.

If the hardness of the water you use is above 63dE or if you are using well water; you are recommended to use filter and water refinement devices.

**Please note: The level of water hardness is preset to level 3.**

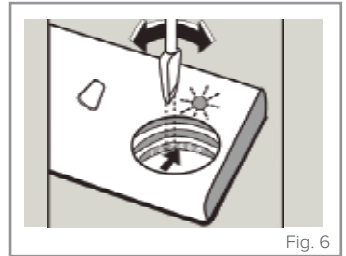
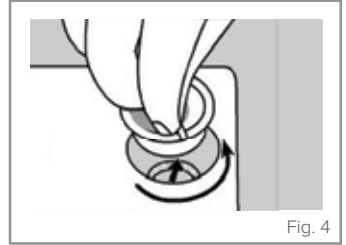
1. Press and hold down the 'Programme selection' button.
2. Press the 'Power' button to switch on the dishwasher.
3. Keep the 'Programme selection' button pressed until the five 'Programme Indicator' lights and the 'End of programme' Indicator light flash.
4. To adjust the level, press the 'Programme selection' button until the required level is selected. The 'Programme' lights will illuminate as in the table of water hardness settings below.
5. To store the selected water hardness level, press the 'Power' button.

Water Hardness Level	British Hardness dE	Display Shows
1	0 – 6	L1
2	7 – 14	L2
3	15 – 21	L3
4	22 – 28	L4
5	29 – 42	L5
6	43 - 63	L6

# Rinse aid

To fill the rinse aid compartment:

1. Open the rinse aid compartment by turning and removing the cap as shown in Fig. 4.
2. Fill the rinse aid compartment until the rinse aid indicator goes dark, as shown in Fig. 5 (where 'a' indicates the compartment is empty, and 'b' indicates the compartment is full).
3. Replace the cap, ensuring the markers on the cap line up with the compartment prior to screwing the cap back in place.



# Rinse aid adjustment

The level of rinse aid use is preset to 4. You can adjust the level of rinse aid use by adjusting as shown in Fig. 6.

- If water stains form on the dishes after a wash, the level should be increased.
- If blue stains which can be wiped away are left on the dishes after a wash, the level should be decreased.

**Please note: Rinse aid ensures better quality wash results and increased drying performance. Always refill the rinse aid when the rinse aid indicator light on the control panel is illuminated.**



# Dishwasher baskets

To adjust the height of the upper basket:

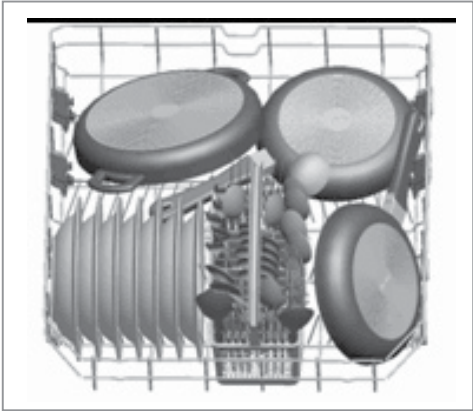
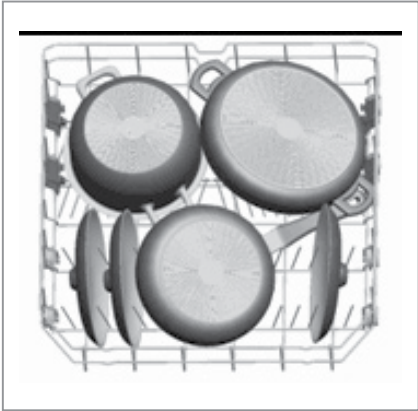
1. Take hold of the basket handles, as shown in fig. 7.
2. Raise the basket up as high as possible and then lower it down until it stops.

The following images are designed as guidance as to best practice (and malpractice) for loading the dishwasher.

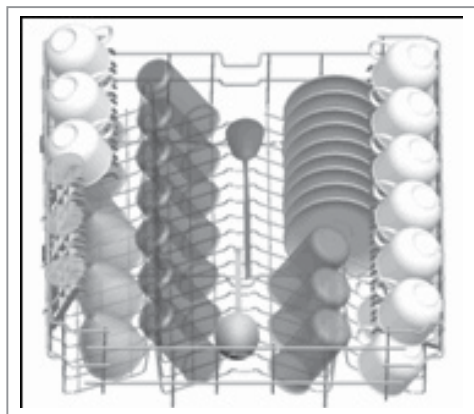


Fig. 7

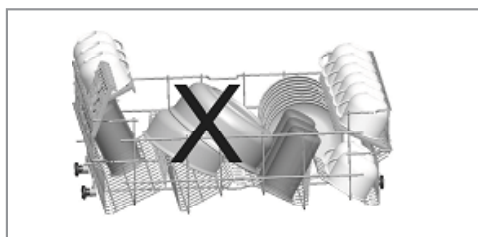
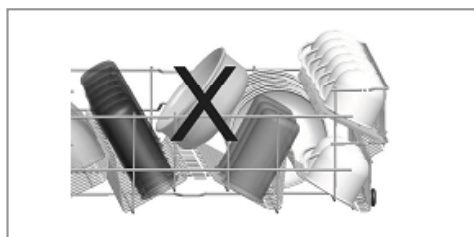
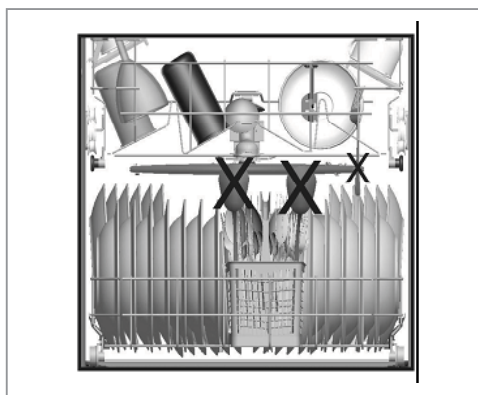
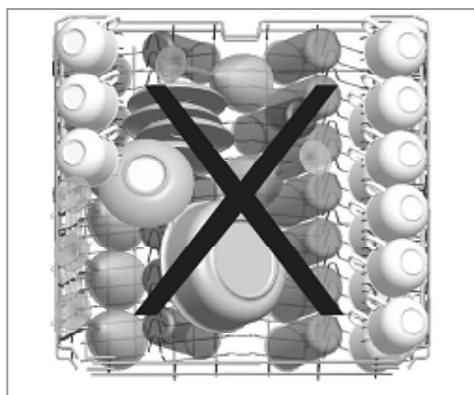
## Lower basket



## Upper basket



## Poorly stacked loads



## **Glass Guards**

The upper basket racks come with a 'GlassGuard' feature. These allow you to place wine glasses securely into the dishwasher and help to prevent the glasses from causing or receiving damage. They are simple to use and involve placing the stem of the glass into the blue grooves along the outside edge of the racks. These are pictured below:



**Glass Guards**

# Standard Loading and Test Data

## Capacity

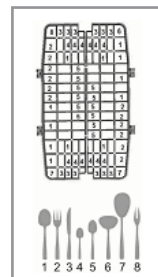
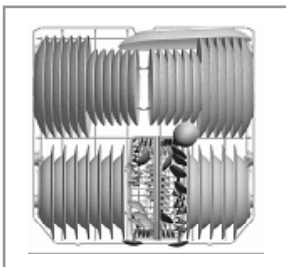
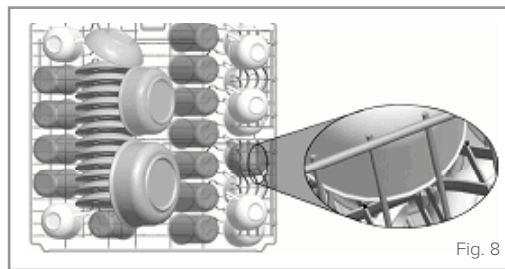
- Upper and lower baskets: 13 place settings.
- The upper basket should be adjusted to high position.
- Cups should be placed onto the dish rack pins.

## Detergent / Rinse aid

- $5 + 25\text{cm}^3$ , in accordance with EN50242-DIN 44990 IEC 436 (international norms) / Rinse aid dosage adjustment: 5.

## Programme test

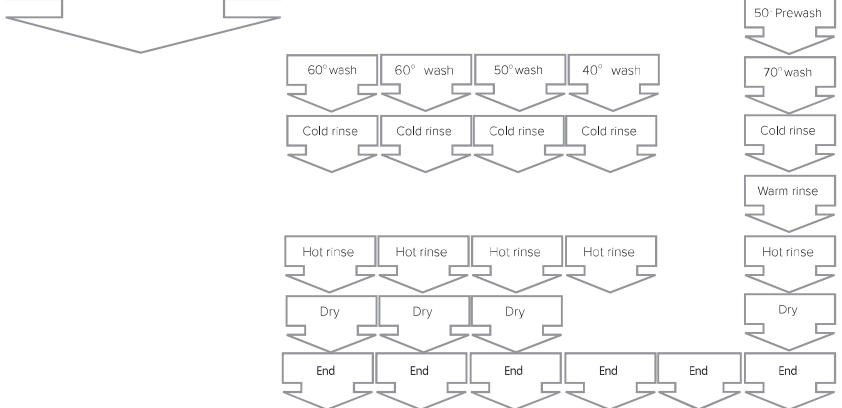
- Eco 50°C, in accordance with EN50242 (international norms.).



# Programme Listing

Programme name and temperature	Auto Intensive 60-70°	Auto-normal 50-60°	Auto-delicate 30-50°	Intensive 60°	Express 60°	Eco 50°	Quick 40°	Prewash -	Intensive+ 70°
Level of soil	High	High	Low	High	Medium	Medium	Low	-	High
Detergent required	A+B	A+B	A	A+B	A+B	A+B	A	-	A+B

The dishwasher is equipped with a sensor that automatically adjusts the washing time, temperature and amount of water required.



Programme duration (mins.)	111-183	100-127	64-92	123	55	162	30	15	161
Electricity consumption (kW hours)	1.22-1.8	1.12-1.3	0.81-0.96	1.55	1.07	0.9	0.88	0.02	1.75
Water consumption (liters)	13.3-24.6	10.9-18.5	10.6-17.7	15	11	9	11	4.2	22.7

---

**Warning: Short programmes do not include a drying stage.**

The values and times provided on the previous page have been obtained under laboratory conditions according to relevant standards.

This information can change depending on the conditions of the dishwasher's use and environment (network voltage, water pressure, water input temperature and environment temperature).

Laboratory measured value in accordance with European standard EN50242

# Care and Maintenance

Before beginning any care or maintenance, you should always disconnect the appliance from the electricity supply, and also turn off the water supply.

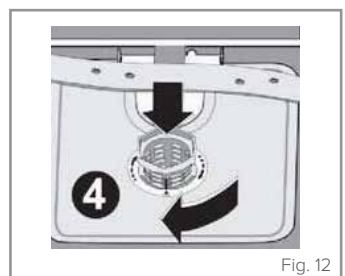
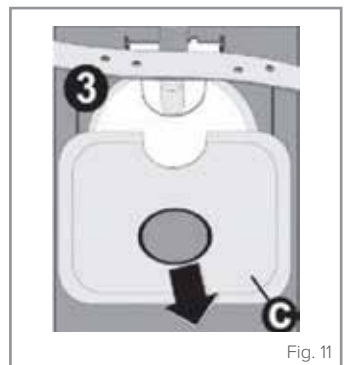
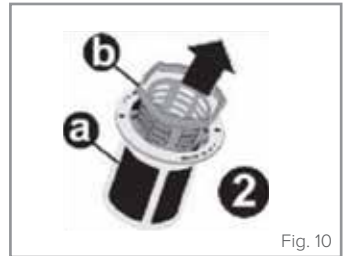
## Door seals

Wipe the dishwasher door seals regularly with a damp cloth to remove any residues.

## Filters

You should clean the filters at least once a month.

1. Remove the lower basket.
2. Turn the microfilter anticlockwise and then lift it out (Fig. 9).
3. Remove the coarse filter from the microfilter (Fig. 10).
4. Remove the base filter from the dishwasher compartment (Fig. 11).  
You should clean and rinse the filters thoroughly before replacing all the sections in reverse order to that above. The microfilter should lock into place once it is secure (Fig. 12).



**Please note: Never run a programme without the filters in place.**

---

**Incorrect fitting of the filters may reduce wash performance and potentially damage your appliance.**

### **Spray arms**

You should clean the spray arms at least once a month.

1. Remove the lower basket.
2. Pull the lower spray arm upwards to remove it.
3. To remove the upper spray arm, first remove the nut on the upper spray arm by turning it. You should clean and rinse the spray arms thoroughly before replacing them. Ensure that the upper spray arm nut is securely tightened when refitting the upper spray arm.

### **Dishwasher interior**














To deal with an accumulation of dirt, oil or limescale in the dishwasher, run an intensive programme with detergent when the dishwasher is empty.

Alternatively, there are specialist dishwasher cleaners available that can be used.



# Fault Codes

In the event of a problem with the appliance, the display may show one of the following fault codes:

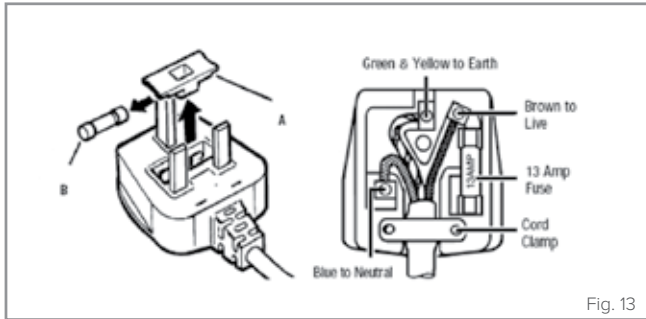
Error Code	Error description	Advice
	Water leakage has been detected	<ul style="list-style-type: none"> <li>• Turn off the dishwasher and disconnect the water supply</li> <li>• Contact CDA Customer Care</li> </ul>
	The waste water cannot be discharged	<ul style="list-style-type: none"> <li>• Drain hose is blocked</li> <li>• The filters of your machine might be blocked</li> <li>• Restart the dishwasher and cancel the programme</li> <li>• If the error continues, contact CDA Customer Care</li> </ul>
	Continual fill error	<ul style="list-style-type: none"> <li>• Contact CDA Customer Care</li> </ul>
	Faulty flow meter	<ul style="list-style-type: none"> <li>• Contact CDA Customer Care</li> </ul>
	Inadequate water supply	<ul style="list-style-type: none"> <li>• Make sure the water tap is fully open</li> <li>• Close the water tap, separate the water inlet hose from the tap and clean the filter.</li> <li>• Restart the dishwasher.</li> <li>• If the error continues, contact CDA Customer Care</li> </ul>
	Faulty NTC	<ul style="list-style-type: none"> <li>• Contact CDA Customer Care</li> </ul>
	Water temperature too high	<ul style="list-style-type: none"> <li>• Contact CDA Customer Care</li> </ul>
	Heater error: Inadequate heat	<ul style="list-style-type: none"> <li>• Contact CDA Customer Care</li> </ul>
	Diverter position problem	<ul style="list-style-type: none"> <li>• Contact CDA Customer Care</li> </ul>
	Alarm is active against water overflow	<ul style="list-style-type: none"> <li>• Contact CDA Customer Care</li> </ul>
	Electronic card parameter faulty	<ul style="list-style-type: none"> <li>• Contact CDA Customer Care</li> </ul>
	Electronic card water hardness faulty	<ul style="list-style-type: none"> <li>• Check the water hardness is set for your water supply</li> <li>• If the error continues, contact CDA Customer Care</li> </ul>
	Faulty turbidity sensor	<ul style="list-style-type: none"> <li>• Contact CDA Customer Care</li> </ul>

# Troubleshooting

Problem	Possible cause
The programme will not start	<p>Check the plug, fuse and circuit breakers of the mains supply.</p> <p>The water tap is turned off.</p> <p>The dishwasher door is not fully closed.</p> <p>The water inlet filter or the machine filters are blocked.</p>
Water remains inside the dishwasher at the end of a programme	<p>The water drain hose is blocked or kinked.</p> <p>The filters are blocked.</p>
The dishwasher stops in the middle of a programme	<p>Power failure.</p> <p>Water inlet failure.</p> <p>Programme is on standby.</p>
Wash performance is of a low standard	<p>Poor loading of dishes hinders wash performance.</p> <p>Insufficient detergent added.</p> <p>Inappropriate wash programme selected.</p> <p>Spray arm is blocked.</p> <p>Filters clogged or incorrectly fitted.</p> <p>Water drain pump is blocked.</p>
White stains on the dishes	<p>Insufficient detergent added.</p> <p>Rinse aid setting is too low.</p> <p>Insufficient dishwasher salt added.</p> <p>Water softener setting is too low.</p> <p>Salt compartment cap may not be completely closed.</p>
The dishes are not completely dry at the end of a programme	<p>A programme without a drying stage was selected.</p> <p>Rinse aid setting is too low.</p> <p>Dishes unloaded too soon (allow time for drying).</p>
There are rust stains on the dishes	<p>Different sets of cutlery should be kept separate.</p> <p>Too much salt (water softener setting is too high).</p> <p>Salt compartment cap not completely closed.</p> <p>Poor appliance earth (check mains electrical supply).</p>
The door is not opening or closing properly	<p>Door tension not correctly adjusted for the decor door.</p>

# Electrical Information

**Warning! This appliance must be earthed.**



The mains lead of this appliance has been fitted with a BS 1363A 13 amp fused plug. To change a fuse in this type of plug, follow the steps below:

1. Remove the fuse cover and fuse.
2. Fit replacement 13A fuse, ASTA approved to BS 1362 type, into the fuse cover.
3. Replace fuse cover.

**Important: Do not use the appliance without the fuse cover in position.**

## How to connect an alternative plug

If the fitted plug is not suitable for your socket outlet, then it should be cut off and disposed of safely to avoid the risk of electric shock. A suitable alternative plug of at least 13 Amp rating to BS 1363 should be used.

---

As the colours of the wires in the mains lead of this appliance may not correspond with the coloured markings identifying the terminals in your plug, proceed as follows:-

- The wire which is coloured GREEN and YELLOW must be connected to the terminal which is marked with the letter (E) or by the Earth symbol  $\perp$  or coloured GREEN and YELLOW.
- The wire which is coloured BLUE must be connected to the terminal which is marked with the letter (N) or coloured BLACK or BLUE.
- The wire which is coloured BROWN must be connected to the terminal which is marked with the letter (L) or coloured RED or BROWN.

If in doubt regarding the electrical connection of this appliance, consult a qualified electrician.

Do not shorten the supply cable, the appliance may require removing for servicing.

**N.B. Ensure that the plug socket is situated in an easily accessible place.**

# Installation

- Do not install this appliance if it is damaged in any way. Installing a damaged appliance may invalidate the warranty and could cause further damage to the surrounding area.
- **Do not hold the appliance by the door or control panel to move it as this may cause damage.** We recommend seeking the help of another individual when moving and installing this appliance.
- We would recommend leaving a certain clearance either side of the dishwasher so that removal of the appliance is easier, should the need arise.
- The water supply tap should be located in an adjacent cupboard so that it can be accessed after installation.
- Ensure the appliance is level by adjusting the feet as necessary. Problems with the level seating of the appliance can lead to issues with the door opening and closing.
- Only use the water inlet supplied with the appliance.
- If the water pressure is above 10 bar, a pressure relief valve should be used.
- After connecting the water supply, check to ensure there are no leaks.
- The water outlet can either be connected to a water drain or to a sink outlet spigot. **Where the dishwasher drain hose is to be connected to a sink spigot, ensure that the spigot is cut/opened (if required) before attaching the drain hose.**
- The drain connection (fig. 16) should be at a minimum of 600mm and a maximum of 1100mm from the floor. The drain hose should be no longer than 4m in length to ensure good performance from the dishwasher.

Figures 14 and 15 **on page 31** show the recommended installations of our dishwashers. The set-ups in these figures should be mimicked wherever possible to help to ensure the best performance of the appliance. **Please carry out the below checks/measures before, during and after installation.**

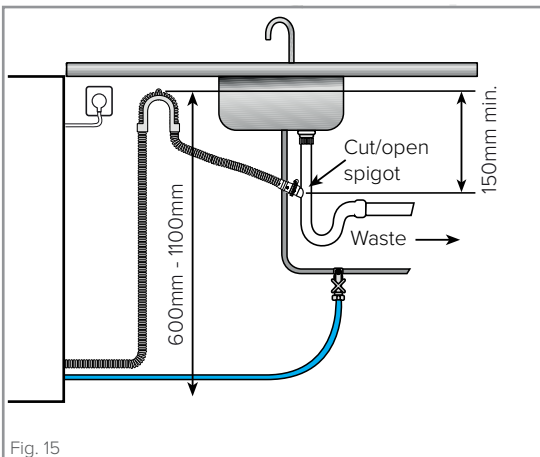
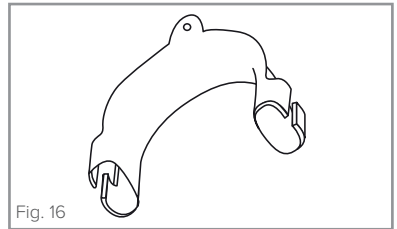
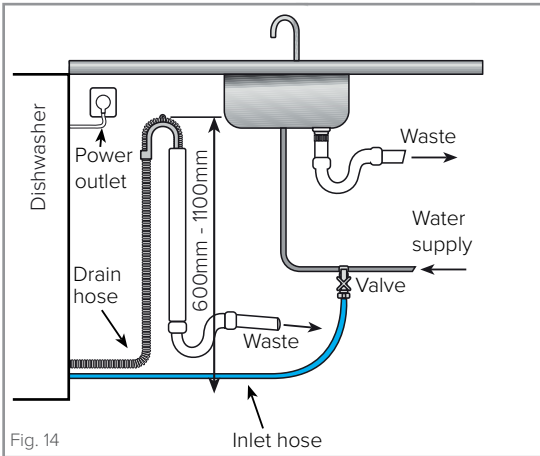
### **Drain hose**

- This can be connected to a water drain or to a sink outlet spigot. Where the hose is to be connected to a spigot, **ensure that the spigot is cut/opened (if required)** before attaching the hose. A circlip can be used to secure this connection. **Observe the 150mm minimum height distance between the spigot and drain hose support as per fig. 15.**
- The drain hose support (fig. 16) must be secured at a minimum of 60cm and a maximum of 110cm from the floor **and must be higher than the sink waste.**
- Should be no longer than 4m in order to ensure good performance.
- **Must be free from kinks, debris or damage.** It is important that this is checked before and after installation.

### **Inlet hose**

- This **must be free from kinks, debris or damage.** This must be checked before and after installation.
- Should have a bend radius of 200mm minimum to ensure the proper flow of water to the appliance.
- Ensure the supply to the hose (water valve) is turned on.

- Use the additional fitting template and kit supplied with the appliance to fit the appliance into the cabinetry, secure it and fit and secure the decor door.
- Adjust the dishwasher door hinge tension as necessary to ensure the appliance door opens and closes properly and safely with the decor door attached. There are labels on the dishwasher door to advise you. An improperly fitted (or adjusted) decor door will prevent the appliance door from opening and closing as normal and could cause issues with operation such as leaks.



# Fitting the decor door

Where non-standard decor doors are to be used, additional fitting instructions are required to ensure compatibility with this product.

The appliance is supplied with a fitting template and these instructions should be followed as normal.

However, the fitting template needs to be located lower down the fascia door. This is shown below:

The amount of offset, Y, depends upon the height of the fascia door and can be calculated as  **$X = 723\text{mm}$** .

For example, if you have a 731mm tall fascia door and are fitting a door to your dishwasher, then  **$Y = 731 - 723 = 8\text{mm}$** .

Ensure that the hinge tensioners are adjusted to balance the weight of the door.

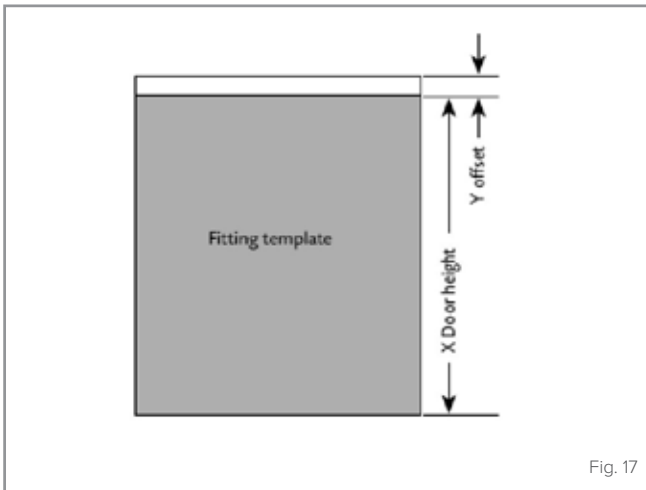


Fig. 17



## IMPORTANT

After completing the installation, test that the appliance fills and drains without issue on any programme. Below are two potential faults that you may encounter (displayed by programme indicator lights and/or fault code) and their potential causes.

Intensive	Super	Eco	Quick	Prewash
✱	✱			✱

Error code - F05

Inadequate water supply. Check that the inlet hose is free from kinks, blockages and that the mains water supply is on.

Intensive	Super	Eco	Quick	Prewash
		✱	✱	✱

Error code - F01, F02

Drainage issue. Check that the drain hose is free from kinks, blockages and is installed at the correct height with the support fitted correctly.

If you have to remove the appliance to perform any final checks (e.g. checking drain hose), please ensure that the hoses and mains lead are not damaged, obscured or kinked when replacing the appliance. Remember to reattach the appliance to the cabinetry using the L brackets provided in the fitting kit.

---

**NOTES:**

## FICHE

Supplier's trade mark	<b>CDA</b>
Supplier's model	<b>WC371</b>
Capacity of dishwasher	<b>13</b>
The energy efficiency class	<b>A+ +</b>
Annual energy consumption in kWh per year (AE <sub>c</sub> ) ( 280 Cycle)*	<b>258</b>
Energy consumption (E <sub>t</sub> ) (kWh per cycle)	<b>0,90</b>
Off mode power consumption (W) (P <sub>o</sub> )	<b>0,50</b>
Left on mode power consumption (W) (P <sub>i</sub> )	<b>1,00</b>
Annual water consumption in litres per year (AW <sub>c</sub> ) ( 280 Cycle)**	<b>2520</b>
Drying efficiency class***	<b>A</b>
Standard programme name****	<b>Eco 50°C</b>
Programme time for standard cycle ( min)	<b>162</b>
Noise dB(A)	<b>45</b>
Freestanding/Built-in	<b>Built-in</b>

\* Energy consumption **258** kwh per year, based on 280 standard cleaning cycles using cold water fill and the consumption of low power modes. Actual energy consumption will depend on how the appliance is used.

\*\* Water consumption **2520** litres per year based on 280 standard cleaning cycles. Actual water consumption will depend on how the appliance is used.

\*\*\*Drying efficiency class **A** on a scale from G (least efficient) to A (most efficient).

\*\*\*\* The "**Eco 50°C**" is the standard cleaning cycle to which the information in the label and the fiche relates. This programme is suitable to clean normally soiled tableware and it is the most efficient programme in terms of combined energy and water consumption.



Please contact our **Customer Care Department** for Service on the details below

**Customer Care Department**

The ICDAI Group Ltd. • Harby Road • Langar • Nottinghamshire • NG13 9HY  
T : 01949 862 012 F : 01949 862 003 E : customer.care@cda.eu

